

UHF FM TRANSCEIVER

TK-3140

SERVICE MANUAL

E · E3 version **SUPPLEMENT**

KENWOOD

Kenwood Corporation

© 2006-10 PRINTED IN JAPAN
B51-8775-00 (S) 243

This service manual (B51-8775-00) applies to products with serial numbers of 80301401 or subsequent serial numbers. Additionally, this TK-3140 has been prepared for RoHS.

Refer to the TK-3140 service manual (B51-8631-00) for any information which has not been covered in this manual.



CONTENTS

PARTS LIST	2
PC BOARD	
TX-RX UNIT (X57-641X-XX)	10
SCHEMATIC DIAGRAM	16



TK-3140

PARTS LIST

* New Parts. Δ indicates safety critical components.
 Parts without **Parts No.** are not supplied.
 Les articles non mentionnés dans le **Parts No.** ne sont pas fournis.
 Teile ohne **Parts No.** werden nicht geliefert.

L: Scandinavia K: USA P: Canada
 Y: PX (Far East, Hawaii) T: England E: Europe
 Y: AAFES (Europe) X: Australia M: Other Areas

TK-3140 (Y50-5642-XX) TX-RX UNIT (X57-641X-XX)

Ref. No.	Address	New parts	Parts No.	Description	Destination
TK-3140					
1	1B		A02-3653-24	CABINET ASSY (4 KEY)	
2	3A		A10-4063-11	CHASSIS	
5	3B	*	B01-0694-03	ESCUTCHEON(BELT HOOK)	
6	2C		B09-0625-03	CAP ACCESSORY	
7	2B		B10-2770-02	FRONT GLASS	
8	1A	*	B38-0890-15	LCD ASSY	
9	1C		B62-1479-20	INSTRUCTION MANUAL	
10	3A	*	B72-2106-14	MODEL NAME-PLATE	E
10	3A		B72-2107-04	MODEL NAME-PLATE	E3
13	3B		E04-0467-05	RF COAXIAL RECEPTACLE(SMA)	
14	3A		E23-1188-04	TERMINAL(ANT)	
15	3A		E23-1189-14	TERMINAL(BATT-)	
16	2A		E37-0978-05	LEAD WIRE WITH CONNECTOR(SW2,SP)	
17	3A		E37-1007-05	LEAD WIRE WITH CONNECTOR(SW1,PTT)	
18	3B	*	E58-0440-15	SQUARE SOCKET(SP/MIC)	
19	3A		E72-0413-03	TERMINAL BLOCK(BATT)	
20	2A		F10-2415-04	SHIELDING PLATE(CPU)	
21	1A		F10-2416-13	SHIELDING PLATE(LCD)	
22	2A		F10-2444-04	SHIELDING PLATE(SP)	
-		*	F10-2463-04	SHIELDING COVER(IC313)	
23	3B		F15-1006-04	SHIELDING PLATE(CHASSIS)	
24	1A		F20-1192-04	INSULATING SHEET(LCD)	
-		*	F20-3307-14	INSULATING SHEET(PTT-CHASSIS)	
25	1B		G10-1304-04	FIBROUS SHEET(CABINET)	
-			G10-1324-04	FIBROUS SHEET(LCD)	
-			G11-2622-04	SHEET(CHASSIS RIB)	
26	3A		G11-4046-14	SHEET(PTT)	
27	2A		G11-4050-04	SHEET(TCXO)	
29	3A		G11-4090-04	SHEET(FINAL FET)	
30	1A		G11-4174-04	SHEET(LCD)	
33	1A,2A	*	G11-4188-04	SHEET(A/3PCB,SHIELDING PLATE)	
34	1B	*	G11-4189-04	SHEET(UPPER SIDE CABINET)	
35	1A	*	G11-4190-04	SHEET(LOWER SIDE CABINET)	
-			G11-4297-04	SHEET(CABINET)	
28	1A		G11-4388-04	SHEET(LCD)	
36	3A		G13-1885-04	CUSHION(CHASSIS)	
-			G13-2010-04	CUSHION(ECM)	
38	3A		G53-1547-04	PACKING(TERMINAL BLOCK)	
-			G53-1620-04	PACKING(ANT)	
39	3B		G53-1710-02	PACKING(TOP)	
37	2B		G53-1732-01	PACKING(4 KEY)	
40	1D		H52-1816-02	ITEM CARTON CASE	
45	2A		J19-5430-03	HOLDER(VOL/ENC)	
47	2A		J21-8424-04	MOUNTING HARDWARE(CHASSIS)	
48	2C		J29-0701-15	BELT HOOK ACCESSORY	
49	1B		J30-1269-04	SPACER(VOL)	
50	2B	*	J82-0078-15	FPC(VOL/ENC)	
51	3B		J82-0079-05	FPC(UNIVERSAL)	
55	1B		K29-9131-03	KNOB(PTT)	
56	1A		K29-9132-03	KEY TOP(SW1,SW2)	
57	1B		K29-9133-13	KNOB(VOL)	
58	1B		K29-9134-13	KNOB(ENC)	

Ref. No.	Address	New parts	Parts No.	Description	Destination
A	2C		N08-0548-24	DRESSED SCREW ACCESSORY	
B	3B	*	N14-0834-04	CIRCULAR NUT(VOL,ENC)	
C	3B		N30-2604-48	PAN HEAD MACHINE SCREW(ANT)	
D	3A	*	N30-2608-48	PAN HEAD MACHINE SCREW(CABINET)	
E	3B		N30-3006-43	PAN HEAD MACHINE SCREW(ESCUTCHEON)	
F	3B		N79-2035-48	PAN HEAD TAPTITE SCREW(TERMINAL)	
G	1A		N83-2005-48	PAN HEAD TAPTITE SCREW(UNIT)	
60	2B		R31-0617-05	VARIABLE RESISTOR(POWER SW/VOL)	
61	2B		S60-0415-05	ROTARY SWITCH(ENCODER)	
62	1B		T07-0732-25	SPEAKER	
63	2D		T90-0798-55	HELICAL ANTENNA	E
63	2D	*	T90-0800-55	HELICAL ANTENNA	E3
64	2B		T91-0630-05	MIC ELEMENT	
TX-RX UNIT (X57-641X-XX) 2-71 :E 2-72 :E3					
D309			B30-2156-05	LED(RED)	
D310			B30-2157-05	LED(YELLOW)	
C1			CK73HB1H471K	CHIP C 470PF K	
C2			CK73HB1H102K	CHIP C 1000PF K	
C4			CC73HCH1H100D	CHIP C 10PF D	
C5			CK73HB1H471K	CHIP C 470PF K	
C8			CK73HB1H102K	CHIP C 1000PF K	
C9			CC73HCH1H100D	CHIP C 10PF D	
C28			CC73HCH1H101J	CHIP C 100PF J	
C29			CK73HB1H102K	CHIP C 1000PF K	
C30			CC73HCH1H100D	CHIP C 10PF D	
C31			CC73HCH1H090D	CHIP C 9.0PF D	E
C31			CC73HCH1H200J	CHIP C 20PF J	E3
C32			CC73HCH1H060D	CHIP C 6.0PF D	
C33			CC73HCH1H150J	CHIP C 15PF J	E
C33			CC73HCH1H560J	CHIP C 56PF J	E3
C34			CC73HCH1H050C	CHIP C 5.0PF C	E
C34			CC73HCH1H100D	CHIP C 10PF D	E3
C36			CC73GCH1H030B	CHIP C 3.0PF B	E3
C36			CC73GCH1H3R5B	CHIP C 3.5PF B	E
C37			CC73GCH1H0R5B	CHIP C 0.5PF B	
C38			CC73GCH1H040B	CHIP C 4.0PF B	E
C38			CC73GCH1H050B	CHIP C 5.0PF B	E3
C39			CK73HB1H471K	CHIP C 470PF K	
C40			CC73GCH1H020B	CHIP C 2.0PF B	E3
C40			CC73GCH1H030B	CHIP C 3.0PF B	E
C41			CC73GCH1H040B	CHIP C 4.0PF B	E
C41			CC73GCH1H090B	CHIP C 9.0PF B	E3
C42			CC73GCH1H2R5B	CHIP C 2.5PF B	E3
C42			CC73GCH1H3R5B	CHIP C 3.5PF B	E
C43			CC73GCH1H0R5B	CHIP C 0.5PF B	
C44			CC73GCH1H040B	CHIP C 4.0PF B	
C45			CK73HB1H471K	CHIP C 470PF K	
C46			CC73HCH1H101J	CHIP C 100PF J	
C47			CC73GCH1H0R5B	CHIP C 0.5PF B	
C48,49			CK73HB1H102K	CHIP C 1000PF K	
C50			CS77AA0J220M	CHIP TNL 22UF 6.3VWV	
C51			CC73HCH1H070D	CHIP C 7.0PF D	

PARTS LIST

TX-RX UNIT (X57-641X-XX)

Ref. No.	Address	New parts	Parts No.	Description	Destination	Ref. No.	Address	New parts	Parts No.	Description	Destination
C52			CK73HB1H102K	CHIP C 1000PF K		C154			CC73HCH1H130J	CHIP C 13PF J	E3
C53			CC73HCH1H330J	CHIP C 33PF J		C154			CC73HCH1H150J	CHIP C 15PF J	E
C54-56			CK73HB1H471K	CHIP C 470PF K		C155			CC73HCH1H050C	CHIP C 5.0PF C	E
C57			CC73HCH1H070D	CHIP C 7.0PF D		C155			CC73HCH1H080D	CHIP C 8.0PF D	E3
						C156			CC73HCH1H020C	CHIP C 2.0PF C	
C60			CK73HB1H102K	CHIP C 1000PF K		C157			CC73HCH1H010C	CHIP C 1.0PF C	E
C65			CC73HCH1H030C	CHIP C 3.0PF C	E	C157			CC73HCH1H040C	CHIP C 4.0PF C	E3
C65,66			CC73HCH1H010C	CHIP C 1.0PF C	E3	C158			CC73HCH1H0R5C	CHIP C 0.5PF C	E3
C66			CC73HCH1H020C	CHIP C 2.0PF C	E	C158			CC73HCH1H030C	CHIP C 3.0PF C	E
C68			CS77CPOJ4R7M	CHIP TAN 4.7UF 6.3WV		C160			CK73HB1H102K	CHIP C 1000PF K	
C100			CK73HB1H471K	CHIP C 470PF K	E3	C164			CC73GCH1H101J	CHIP C 100PF J	E3
C100-102			CK73HB1H471K	CHIP C 470PF K	E	C164			CC73GCH1H330G	CHIP C 33PF G	E
C101			CC73HCH1H070D	CHIP C 7.0PF D	E3	C200			CK73GB1A224K	CHIP C 0.22UF K	
C102			CK73HB1H471K	CHIP C 470PF K	E3	C201			CK73HB1A104K	CHIP C 0.10UF K	
C103			CC73HCH1H070D	CHIP C 7.0PF D	E	C202			CK73HB1H221K	CHIP C 220PF K	
C103			CC73HCH1H090D	CHIP C 9.0PF D	E3	C203-205			CK73HB1A104K	CHIP C 0.10UF K	
C104,105			CK73HB1H471K	CHIP C 470PF K		C206			CK73HB1C103K	CHIP C 0.010UF K	
C106			CC73HCH1H060D	CHIP C 6.0PF D		C207			CK73HB1H471K	CHIP C 470PF K	
C108			CK73HB1A104K	CHIP C 0.10UF K		C208,209			CK73HB1H221K	CHIP C 220PF K	
C109			CC73HCH1H050C	CHIP C 5.0PF C	E	C210			CK73HB1A104K	CHIP C 0.10UF K	
C109			CC73HCH1H080D	CHIP C 8.0PF D	E3	C211			CK73HB1H102K	CHIP C 1000PF K	
C110			CC73HCH1H130J	CHIP C 13PF J		C212			CC73HCH1H220J	CHIP C 22PF J	
C111			CK73HB1H471K	CHIP C 470PF K		C213			CC73HCH1H100D	CHIP C 10PF D	
C115			CK73HB1H471K	CHIP C 470PF K		C214			CK73HB1A104K	CHIP C 0.10UF K	
C116			CC73HCH1H100D	CHIP C 10PF D	E	C215			C92-0773-05	CHIP-TAN 15UF 6.3WV	
C116			CC73HCH1H330J	CHIP C 33PF J	E3	C216			CK73HB1A104K	CHIP C 0.10UF K	
C118			CK73HB1A104K	CHIP C 0.10UF K		C217			CK73HB1H221K	CHIP C 220PF K	
C119			CC73GCH1H270G	CHIP C 27PF G	E	C218			CK73HB1A104K	CHIP C 0.10UF K	
C119			CC73GCH1H390J	CHIP C 39PF J	E3	C219			CK73HB1A333K	CHIP C 0.033UF K	
C122			CK73HB1H471K	CHIP C 470PF K		C220			CK73HB1A104K	CHIP C 0.10UF K	
C123			CS77AA1C100M	CHIP TNL 10UF 16WV		C221			CC73HCH1H680J	CHIP C 68PF J	
C124			CK73GB0J105K	CHIP C 1.0UF K		C222			CK73HB1A104K	CHIP C 0.10UF K	
C125			CK73HB1H102K	CHIP C 1000PF K		C223			CK73HB1C103K	CHIP C 0.010UF K	
C126,127			CK73HB1H471K	CHIP C 470PF K		C224			CS77CPOJ100M	CHIP TAN 10UF 6.3WV	
C128			CC73HCH1H101J	CHIP C 100PF J		C225			CK73HB1C103K	CHIP C 0.010UF K	
C129,130			CK73HB1H471K	CHIP C 470PF K		C227			CK73HB1A104K	CHIP C 0.10UF K	
C131			CC73GCH1H270G	CHIP C 27PF G		C228,229			CK73HB1C103K	CHIP C 0.010UF K	
C132			CK73HB1C103K	CHIP C 0.010UF K		C230			CC73HCH1H100D	CHIP C 10PF D	
C133		*	CK73GB1A105K	CHIP C 1.0UF K		C231			CK73HB1C103K	CHIP C 0.010UF K	
C134			CK73HB1A104K	CHIP C 0.10UF K		C232			CK73HB1H471K	CHIP C 470PF K	
C135			CC73GCH1H200G	CHIP C 20PF G		C233			CK73HB1C103K	CHIP C 0.010UF K	
C136			CK73HB1H471K	CHIP C 470PF K		C234			CK73HB1H471K	CHIP C 470PF K	
C137			CK73HB1C103K	CHIP C 0.010UF K		C236			CC73HCH1H020C	CHIP C 2.0PF C	
C139			CK73HB1H471K	CHIP C 470PF K		C237			CC73HCH1H150J	CHIP C 15PF J	E3
C143			CC73GCH1H100C	CHIP C 10PF C	E	C237			CC73HCH1H180J	CHIP C 18PF J	E
C143			CC73GCH1H150G	CHIP C 15PF G	E3	C238			CC73HCH1H100D	CHIP C 10PF D	E
C144			CC73GCH1H070B	CHIP C 7.0PF B	E	C238			CC73HCH1H110J	CHIP C 11PF J	E3
C144			CC73GCH1H080B	CHIP C 8.0PF B	E3	C239			CK73HB1H471K	CHIP C 470PF K	
C146			CC73GCH1H270J	CHIP C 27PF J		C240			CC73HCH1HR75C	CHIP C 0.75PF C	E
C147			CK73HB1H471K	CHIP C 470PF K		C240			CC73HCH1H010C	CHIP C 1.0PF C	E3
C148			CC73HCH1H050C	CHIP C 5.0PF C		C241			CC73HCH1H070D	CHIP C 7.0PF D	
C149			CC73HCH1H101J	CHIP C 100PF J	E	C242			CK73HB1A104K	CHIP C 0.10UF K	
C149			CK73HB1H471K	CHIP C 470PF K	E3	C243			CK73HB1H561K	CHIP C 560PF K	
C150			CC73HCH1H020C	CHIP C 2.0PF C	E	C244			CC73GCH1H030B	CHIP C 3.0PF B	E3
C150			CC73HCH1H070D	CHIP C 7.0PF D	E3	C244			CC73GCH1H050B	CHIP C 5.0PF B	E
C151			CC73HCH1H010C	CHIP C 1.0PF C	E3	C245			CK73HB1H471K	CHIP C 470PF K	
C151			CC73HCH1H1R5C	CHIP C 1.5PF C	E	C248			CC73HCH1H330J	CHIP C 33PF J	
C152			CC73HCH1H040C	CHIP C 4.0PF C	E	C249			CC73HCH1H030C	CHIP C 3.0PF C	
C152			CC73HCH1H060D	CHIP C 6.0PF D	E3	C250			CK73HB1H471K	CHIP C 470PF K	
C153			CC73HCH1H020C	CHIP C 2.0PF C		C251			CC73GCH1H020B	CHIP C 2.0PF B	E

PARTS LIST

TX-RX UNIT (X57-641X-XX)

Ref. No.	Address	New parts	Parts No.	Description	Destination	Ref. No.	Address	New parts	Parts No.	Description	Destination
C251			CC73GCH1H030B	CHIP C 3.0PF B	E3	C331			CK73HB1E682K	CHIP C 6800PF K	
C252			CC73HCH1H330J	CHIP C 33PF J		C332			CK73HB1C103K	CHIP C 0.010UF K	
C253			CK73HB1A104K	CHIP C 0.10UF K		C333			CK73HB1H332K	CHIP C 3300PF K	
C255			CK73HB1A104K	CHIP C 0.10UF K		C334,335			CK73HB1C103K	CHIP C 0.010UF K	
C256			CC73HCH1H330J	CHIP C 33PF J		C336,337			CC73HCH1H270J	CHIP C 27PF J	
C257-260			CK73HB1H471K	CHIP C 470PF K		C338			CC73HCH1H160J	CHIP C 16PF J	
C261			CK73GB1H471K	CHIP C 470PF K		C339-342			CK73HB1C103K	CHIP C 0.010UF K	
C263			CC73HCH1H330J	CHIP C 33PF J		C344			CS77CP0J100M	CHIP TAN 10UF 6.3WV	
C264			CK73HB1H471K	CHIP C 470PF K		C345			CK73GB1A474K	CHIP C 0.47UF K	
C266			CK73HB1H471K	CHIP C 470PF K		C346			CC73HCH1H470J	CHIP C 47PF J	
C267			CC73GCH1H030B	CHIP C 3.0PF B		C347			CK73HB1C103K	CHIP C 0.010UF K	
C268			CC73HCH1H330J	CHIP C 33PF J		C348			CK73GB1A474K	CHIP C 0.47UF K	
C269			CC73GCH1H030B	CHIP C 3.0PF B	E	C349			CK73HB1C153K	CHIP C 0.015UF K	
C269			CC73GCH1H040B	CHIP C 4.0PF B	E3	C350	*		CS77CP0G3R3M	CHIP TAN 3.3U 4.0WV	
C270			CC73HCH1H030C	CHIP C 3.0PF C		C351			CK73HB1C103K	CHIP C 0.010UF K	
C274			CC73GCH1H030B	CHIP C 3.0PF B	E	C352-354			CK73HB1A104K	CHIP C 0.10UF K	
C274			CC73GCH1H3R5B	CHIP C 3.5PF B	E3	C355			CS77AA1A100M	CHIP TNTL 10UF 10WV	
C275			CK73HB1E472K	CHIP C 4700PF K		C356			CC73HCH1H470J	CHIP C 47PF J	
C276			CK73HB1H471K	CHIP C 470PF K		C357,358			CS77AA0J220M	CHIP TNTL 22UF 6.3WV	
C277			CC73GCH1H030B	CHIP C 3.0PF B	E3	C359			CC73HCH1H470J	CHIP C 47PF J	
C277			CC73GCH1H3R5B	CHIP C 3.5PF B	E	C362			CC73HCH1H470J	CHIP C 47PF J	
C278-280			CK73HB1A104K	CHIP C 0.10UF K		C364			CC73HCH1H470J	CHIP C 47PF J	
C281			CK73HB1H471K	CHIP C 470PF K		C369			CC73HCH1H101J	CHIP C 100PF J	
C282			CK73HB1H102K	CHIP C 1000PF K		C371			CC73HCH1H470J	CHIP C 47PF J	
C283,284			CK73HB1A104K	CHIP C 0.10UF K		C375			CC73HCH1H470J	CHIP C 47PF J	
C285			CC73GCH1H0R5B	CHIP C 0.5PF B	E	C382			CK73HB1A104K	CHIP C 0.10UF K	
C286			CC73GCH1H050B	CHIP C 5.0PF B	E	C383,384			CK73HB1H102K	CHIP C 1000PF K	
C286			CC73GCH1H4R5B	CHIP C 4.5PF B	E3	C386			CC73HCH1H470J	CHIP C 47PF J	
C288			CK73HB1H471K	CHIP C 470PF K		C388			CK73HB1H102K	CHIP C 1000PF K	
C289			CC73GCH1H020B	CHIP C 2.0PF B	E	C389			CC73HCH1H470J	CHIP C 47PF J	
C289			CC73GCH1H030B	CHIP C 3.0PF B	E3	C390			CK73HB1A104K	CHIP C 0.10UF K	
C290			CC73GCH1H1R5B	CHIP C 1.5PF B	E3	C391,392			CK73HB1C103K	CHIP C 0.010UF K	
C290			CC73GCH1H3R5B	CHIP C 3.5PF B	E	C394,395			CK73HB1A104K	CHIP C 0.10UF K	
C292			CC73HCH1H030C	CHIP C 3.0PF C		C396			CK73HB1C103K	CHIP C 0.010UF K	
C293			CC73GCH1H020B	CHIP C 2.0PF B	E	C397,398			CK73HB1A104K	CHIP C 0.10UF K	
C293			CC73GCH1H1R5B	CHIP C 1.5PF B	E3	C399			CK73HB1E562K	CHIP C 5600PF K	
C294			CK73GB1H471K	CHIP C 470PF K		C400			CK73HB1H471K	CHIP C 470PF K	
C295			CK73HB1H471K	CHIP C 470PF K		C402-405			CK73HB1H102K	CHIP C 1000PF K	
C298			CK73HB1H471K	CHIP C 470PF K		C408			CK73HB1H102K	CHIP C 1000PF K	
C300			CS77CP0J100M	CHIP TAN 10UF 6.3WV		C410			CK73FB1A475K	CHIP C 4.7UF K	
C301			CK73HB1H471K	CHIP C 470PF K		C411		*	CK73GB1A105K	CHIP C 1.0UF K	
C304			CC73HCH1H220J	CHIP C 22PF J		C413			CS77CP0J100M	CHIP TAN 10UF 6.3WV	
C310			CK73HB1C103K	CHIP C 0.010UF K		C415			CC73HCH1H101J	CHIP C 100PF J	
C311			CC73HCH1H101J	CHIP C 100PF J		C416			CS77CP0J100M	CHIP TAN 10UF 6.3WV	
C312			CS77CP0J100M	CHIP TAN 10UF 6.3WV		C417			CK73GB0J105K	CHIP C 1.0UF K	
C313			CK73HB1A104K	CHIP C 0.10UF K		C419			CK73HB1H102K	CHIP C 1000PF K	
C314			CK73HB1H471K	CHIP C 470PF K		C420			CC73HCH1H101J	CHIP C 100PF J	
C315			CS77CP0J100M	CHIP TAN 10UF 6.3WV		C421		*	CK73GB1A105K	CHIP C 1.0UF K	
C316			CK73HB1A333K	CHIP C 0.033UF K		C422			CK73GB0J105K	CHIP C 1.0UF K	
C318			CK73HB1H221K	CHIP C 220PF K		C423			C92-0773-05	CHIP-TAN 15UF 6.3WV	
C319			CC73HCH1H101J	CHIP C 100PF J		C424			CC73HCH1H101J	CHIP C 100PF J	
C320			CK73HB1A104K	CHIP C 0.10UF K		C425			CK73HB1A104K	CHIP C 0.10UF K	
C321			CK73HB1H271K	CHIP C 270PF K		C426			CC73HCH1H101J	CHIP C 100PF J	
C322			CK73HB1H152K	CHIP C 1500PF K		C431			CC73HCH1H101J	CHIP C 100PF J	
C323			CK73HB1H222K	CHIP C 2200PF K		C500-503			CK73HB1A104K	CHIP C 0.10UF K	
C325			CK73HB1C123K	CHIP C 0.012UF K		C504			CK73GB1C104K	CHIP C 0.10UF K	
C327			CK73HB1H681K	CHIP C 680PF K		C506			CC73HCH1H220J	CHIP C 22PF J	
C328			CK73GB1C683K	CHIP C 0.068UF K		C507			CK73HB1A104K	CHIP C 0.10UF K	
C329			CK73GB0J105K	CHIP C 1.0UF K		C508			CK73HB1H821K	CHIP C 820PF K	
C330			CK73HB1A104K	CHIP C 0.10UF K		C509			CC73HCH1H220J	CHIP C 22PF J	

PARTS LIST

TX-RX UNIT (X57-641X-XX)

Ref. No.	Address	New parts	Parts No.	Description	Destination	Ref. No.	Address	New parts	Parts No.	Description	Destination
C510			CC73HCH1H820J	CHIP C 82PF J		C908,909			CK73HB1H471K	CHIP C 470PF K	
C511			CC73HCH1H680J	CHIP C 68PF J		C910,911			CK73HB1H102K	CHIP C 1000PF K	
C512			CK73HB1A473K	CHIP C 0.047UF K		TC1,2			C05-0384-05	CERAMIC TRIMMER CAP(10PF)	
C513,514			CK73HB1A104K	CHIP C 0.10UF K							
C515			CK73GB1H122K	CHIP C 1200PF K							
C516			CS77CP0J4R7M	CHIP TAN 4.7UF 6.3WV		CN300		*	E40-6256-15	SOCKET FOR PIN ASSY	
C517			CK73HB1A104K	CHIP C 0.10UF K		CN301,302			E40-6453-05	FLAT CABLE CONNECTOR	
C518,519			CS77CP0J4R7M	CHIP TAN 4.7UF 6.3WV		CN303-306			E40-6092-05	PIN ASSY	
C520			CC73HCH1H120J	CHIP C 12PF J		CN400			E40-6453-05	FLAT CABLE CONNECTOR	
C522			CK73HB1A104K	CHIP C 0.10UF K		CN500			E40-6257-15	PIN ASSY	
C523			CK73HB1H271K	CHIP C 270PF K		-			F20-1190-04	INSULATING SHEET	
C524			CC73HCH1E181J	CHIP C 180PF J		F400			F53-0324-05	FUSE(2.5A/32V)	
C525			CK73HB1H102K	CHIP C 1000PF K		CD200			L79-1834-05	TUNING COIL	
C526			CK73HB1C103K	CHIP C 0.010UF K		CF200			L72-0962-05	CERAMIC FILTER	
C527			CK73HB1A104K	CHIP C 0.10UF K		CF201			L72-0934-05	CERAMIC FILTER	
C531			CC73HCH1H120J	CHIP C 12PF J		L1			L41-4795-39	SMALL FIXED INDUCTOR(4.7UH)	
C537			CK73HB1A104K	CHIP C 0.10UF K		L8			L40-1085-92	SMALL FIXED INDUCTOR(100NH)	E
C539,540		*	CS77AP1C1R5M	CHIP TAN 1.5UF 16WV		L8			L40-2785-92	SMALL FIXED INDUCTOR(270NH)	E3
C541			CK73HB1A104K	CHIP C 0.10UF K		L9			L92-0163-05	BEADS CORE	
C542,543			CK73HB1H102K	CHIP C 1000PF K		L10			L40-1085-92	SMALL FIXED INDUCTOR(100NH)	E
C544,545			CK73HB1A104K	CHIP C 0.10UF K		L10			L40-3391-86	SMALL FIXED INDUCTOR(3.3UH)	E3
C546			CC73HCH1H101J	CHIP C 100PF J	E	L11			L40-2785-92	SMALL FIXED INDUCTOR(270NH)	
C710			CC73GCH1H2R5B	CHIP C 2.5PF B		L12			L40-1085-92	SMALL FIXED INDUCTOR(100NH)	E
C720			CS77CP0J4R7M	CHIP TAN 4.7UF 6.3WV		L12			L40-3391-86	SMALL FIXED INDUCTOR(3.3UH)	E3
C730		*	CS77BJ0J2R2M	CHIP TAN 2.2UF 6.3WV		L15			L40-2278-67	SMALL FIXED INDUCTOR(22NH)	E
C801-803			CC73HCH1H101J	CHIP C 100PF J		L15,16			L40-2778-67	SMALL FIXED INDUCTOR(27NH)	E3
C805			CK73GB1C104K	CHIP C 0.10UF K		L16			L40-2778-67	SMALL FIXED INDUCTOR(27NH)	E
C806			CK73HB1A104K	CHIP C 0.10UF K		L17,18			L41-2285-03	SMALL FIXED INDUCTOR(220NH)	
C807			C92-0773-05	CHIP-TAN 15UF 6.3WV		L19,20			L40-3391-86	SMALL FIXED INDUCTOR(3.3UH)	
C809			CK73HB1H471K	CHIP C 470PF K		L21			L40-2275-92	SMALL FIXED INDUCTOR(22NH)	E
C811			CS77AA1VR33M	CHIP TNL 0.33UF 35WV	E3	L21			L40-2775-92	SMALL FIXED INDUCTOR(27NH)	E3
C811			CS77CA1VOR1M	CHIP TNL 0.1UF 35WV	E	L22			L92-0163-05	BEADS CORE	
C812		*	CS77AP1A3R3M	CHIP TNL 3.3UF 10WV	E3	L23			L40-2275-92	SMALL FIXED INDUCTOR(22NH)	
C812			CS77BP1C010M	CHIP TNL 10UF 16WV	E	L100			L40-1875-92	SMALL FIXED INDUCTOR(18NH)	
C813			CS77AA1VR33M	CHIP TNL 0.33UF 35WV	E3	L101			L40-2275-92	SMALL FIXED INDUCTOR(22NH)	
C813			C92-0863-05	CHIP-TAN 0.047UF 35WV	E	L102			L92-0162-05	BEADS CORE	
C814			CC73GCH1H030B	CHIP C 3.0PF B	E	L103			L41-1575-43	SMALL FIXED INDUCTOR(15NH)	
C814			CC73GCH1H3R5B	CHIP C 3.5PF B	E3	L104			L92-0149-05	CHIP FERRITE	
C815			CC73HCH1H101J	CHIP C 100PF J		L106			L34-4602-05	AIR-CORE COIL	
C817			CC73HCH1H100D	CHIP C 10PF D		L107			L92-0149-05	CHIP FERRITE	
C818			CC73HCH1H220J	CHIP C 22PF J		L108			L41-2285-43	SMALL FIXED INDUCTOR(220NH)	
C819			CC73HCH1H100D	CHIP C 10PF D		L109			L34-4572-05	AIR-CORE COIL	
C820			CC73HCH1H220J	CHIP C 22PF J		L110-112			L34-4564-05	AIR-CORE COIL	
C821			CC73HCH1H100D	CHIP C 10PF D		L113			L41-1092-44	SMALL FIXED INDUCTOR(1UH)	
C822			CC73HCH1H220J	CHIP C 22PF J		L114,115			L40-8265-57	SMALL FIXED INDUCTOR(8.2NH)	
C823			CC73HCH1H100D	CHIP C 10PF D		L116			L40-1263-92	SMALL FIXED INDUCTOR(1.2NH)	E
C824			CC73HCH1H220J	CHIP C 22PF J		L116			L40-1563-92	SMALL FIXED INDUCTOR(1.5NH)	E3
C825			CC73HCH1H100D	CHIP C 10PF D		L201			L40-1091-86	SMALL FIXED INDUCTOR(1.0UH)	
C826			CC73HCH1H220J	CHIP C 22PF J		L202		*	L40-1591-86	SMALL FIXED INDUCTOR(1.5UH)	
C827			CC73HCH1H100D	CHIP C 10PF D		L203			L92-0163-05	BEADS CORE	
C828			CC73HCH1H220J	CHIP C 22PF J		L204			L41-1095-33	SMALL FIXED INDUCTOR(1.0UH)	
C841,842			CC73GCH1H471J	CHIP C 470PF J		L205			L40-1875-57	SMALL FIXED INDUCTOR(18.0NH)	E
C843-849			CK73HB1H471K	CHIP C 470PF K		L205,206			L40-1875-57	SMALL FIXED INDUCTOR(18.0NH)	E3
C850			CK73HB1C103K	CHIP C 0.010UF K		L206			L40-2275-57	SMALL FIXED INDUCTOR(22.0NH)	E
C901			CK73HB1A104K	CHIP C 0.10UF K		L207			L40-2775-92	SMALL FIXED INDUCTOR(27NH)	E
C902			CK73GB1A224K	CHIP C 0.22UF K		L207			L40-3375-92	SMALL FIXED INDUCTOR(33NH)	E3
C903			CC73HCH1H100D	CHIP C 10PF D		L209-211			L41-1078-14	SMALL FIXED INDUCTOR(10NH)	E3
C904,905			CC73HCH1H050C	CHIP C 5.0PF C		L209-211			L41-8268-14	SMALL FIXED INDUCTOR(8.2NH)	E
C906			CK73HB1H102K	CHIP C 1000PF K	E						
C907			CC73HCH1H101J	CHIP C 100PF J							

PARTS LIST

TX-RX UNIT (X57-641X-XX)

Ref. No.	Address	New parts	Parts No.	Description	Destination	Ref. No.	Address	New parts	Parts No.	Description	Destination
L212			L92-0163-05	BEADS CORE		R104			RK73HB1J220J	CHIP R 22 J 1/16W	
L213			L41-2285-03	SMALL FIXED INDUCTOR(220NH)		R105			RK73HB1J681J	CHIP R 680 J 1/16W	
L215			L41-1078-14	SMALL FIXED INDUCTOR(10NH)	E3	R106			RK73HB1J152J	CHIP R 1.5K J 1/16W	
L215			L41-8268-14	SMALL FIXED INDUCTOR(8.2NH)	E	R107			RK73HB1J100J	CHIP R 10 J 1/16W	
L217			L41-1078-14	SMALL FIXED INDUCTOR(10NH)	E3	R108,109			RK73HB1J331J	CHIP R 330 J 1/16W	
L217			L41-8268-14	SMALL FIXED INDUCTOR(8.2NH)	E	R111			RK73HB1J180J	CHIP R 18 J 1/16W	
L219			L41-4778-03	SMALL FIXED INDUCTOR(47NH)		R112			RK73HB1J331J	CHIP R 330 J 1/16W	
L300-313			L92-0163-05	BEADS CORE		R114			RK73HB1J124J	CHIP R 120K J 1/16W	
L314-317			L92-0408-05	CHIP FERRITE		R115			RK73HB1J473J	CHIP R 47K J 1/16W	
L320			L92-0163-05	BEADS CORE		R116			RK73HB1J220J	CHIP R 22 J 1/16W	
L400			L92-0149-05	CHIP FERRITE		R119,120			RK73EB2ER39K	CHIP R 0.39 K 1/4W	
L801			L92-0163-05	BEADS CORE		R121			RK73HB1J473J	CHIP R 47K J 1/16W	
L802			L92-0470-05	CHIP FERRITE		R122			RK73FB2B000JX	CHIP R 0.0 J 1/8W	
L805			L40-1875-92	SMALL FIXED INDUCTOR(18NH)		R123			RK73EB2ER39K	CHIP R 0.39 K 1/4W	
L807			L41-3369-16	SMALL FIXED INDUCTOR(3.3NH)	E3	R124			RK73HB1J000J	CHIP R 0.0 J 1/16W	E
L808			L92-0163-05	BEADS CORE		R124			RK73HB1J393J	CHIP R 39K J 1/16W	E3
L901			L40-1275-92	SMALL FIXED INDUCTOR(12NH)		R125			RK73HB1J101J	CHIP R 100 J 1/16W	
L902			L40-1875-57	SMALL FIXED INDUCTOR(18.0NH)	E	R126			RK73HB1J393J	CHIP R 39K J 1/16W	E3
L903			L40-1085-92	SMALL FIXED INDUCTOR(100NH)		R126			RK73HB1J473J	CHIP R 47K J 1/16W	E
L904			L92-0419-15	CHIP FERRITE		R127-129			RK73HH1J154D	CHIP R 150K D 1/1	
X1			L77-1871-05	TCXO (16.8MHZ)		R131-133			RK73HH1J154D	CHIP R 150K D 1/1	
X200			L77-1760-15	CRYSTAL RESONATOR(44.395MHZ)		R134			RK73HB1J103J	CHIP R 10K J 1/16W	
X300			L77-1810-05	CRYSTAL RESONATOR(9.8304MHZ)		R136			RK73HB1J473J	CHIP R 47K J 1/16W	
X500			L77-1517-05	CRYSTAL RESONATOR(3.6864MHZ)		R138			RK73HB1J102J	CHIP R 1.0K J 1/16W	E
X501			L78-0479-05	RESONATOR (3.58MHZ)		R138			RK73HB1J332J	CHIP R 3.3K J 1/16W	E3
XF200			L71-0530-05	MCF (44.85MHZ)		R139			RK73HH1J105D	CHIP R 1.0M D 1/16W	
CP2			RK75HA1J102J	CHIP-COM 1.0K J 1/16W		R140			RK73HB1J222J	CHIP R 2.2K J 1/16W	E3
CP300-313			RK75HA1J102J	CHIP-COM 1.0K J 1/16W		R140			RK73HB1J272J	CHIP R 2.7K J 1/16W	E
CP314			RK75HA1J473J	CHIP-COM 47K J 1/16W		R142,143			RK73HB1J104J	CHIP R 100K J 1/16W	
CP315			RK75HA1J102J	CHIP-COM 1.0K J 1/16W		R144			RK73FB2B000JX	CHIP R 0.0 J 1/8W	E
CP316			RK75HA1J473J	CHIP-COM 47K J 1/16W		R145,146			RK73HB1J271J	CHIP R 270 J 1/16W	
CP317-320			RK75HA1J102J	CHIP-COM 1.0K J 1/16W		R147			RK73GB2A000JX	CHIP R 0.0 J 1/10W	
CP322			RK75HA1J102J	CHIP-COM 1.0K J 1/16W		R149			RK73HB1J000J	CHIP R 0.0 J 1/16W	
CP323,324			RK75HA1J473J	CHIP-COM 47K J 1/16W		R151			RK73HB1J000J	CHIP R 0.0 J 1/16W	
CP326,327			RK75HA1J473J	CHIP-COM 47K J 1/16W		R152			RK73HB1J477J	CHIP R 4.7 J 1/16W	
CP400,401			RK75HA1J473J	CHIP-COM 47K J 1/16W		R200			RK73HB1J224J	CHIP R 220K J 1/16W	
R1			RK73HB1J101J	CHIP R 100 J 1/16W		R201			RK73HB1J104J	CHIP R 100K J 1/16W	
R13-15			RK73HB1J473J	CHIP R 47K J 1/16W		R202			RK73HB1J123J	CHIP R 12K J 1/16W	
R16			RK73HB1J181J	CHIP R 180 J 1/16W		R203			RK73HH1J823D	CHIP R 82K D 1/16W	
R17			RK73HB1J101J	CHIP R 100 J 1/16W		R204			RK73HH1J824D	CHIP R 820K D 1/16W	
R18			RK73HB1J151J	CHIP R 150 J 1/16W		R205			RK73HB1J334J	CHIP R 330K J 1/16W	
R19			RK73HB1J101J	CHIP R 100 J 1/16W		R206			RK73HB1J473J	CHIP R 47K J 1/16W	
R20			RK73HB1J104J	CHIP R 100K J 1/16W		R207			RK73HB1J154J	CHIP R 150K J 1/16W	
R21			RK73HB1J154J	CHIP R 150K J 1/16W		R208			RK73HB1J472J	CHIP R 4.7K J 1/16W	
R22			RK73HB1J472J	CHIP R 4.7K J 1/16W		R209			RK73HB1J103J	CHIP R 10K J 1/16W	
R23			RK73HB1J101J	CHIP R 100 J 1/16W		R210			RK73HB1J123J	CHIP R 12K J 1/16W	
R24			RK73HB1J102J	CHIP R 1.0K J 1/16W		R211			RK73HB1J223J	CHIP R 22K J 1/16W	
R25			RK73HB1J682J	CHIP R 6.8K J 1/16W		R212			RK73HB1J472J	CHIP R 4.7K J 1/16W	
R26			RK73HB1J103J	CHIP R 10K J 1/16W		R213			RK73HB1J123J	CHIP R 12K J 1/16W	
R27			RK73HB1J271J	CHIP R 270 J 1/16W		R215			RK73HB1J332J	CHIP R 3.3K J 1/16W	
R28			RK73HH1J333D	CHIP R 33K D 1/16W		R216			RK73HB1J472J	CHIP R 4.7K J 1/16W	
R29			RK73HH1J104D	CHIP R 100K D 1/16W		R217			RK73HB1J334J	CHIP R 330K J 1/16W	
R31			RK73HB1J470J	CHIP R 47 J 1/16W		R218			RK73HB1J123J	CHIP R 12K J 1/16W	
R33			RK73HB1J000J	CHIP R 0.0 J 1/16W		R219			RK73HB1J224J	CHIP R 220K J 1/16W	
R35			RK73HB1J000J	CHIP R 0.0 J 1/16W		R220			RK73HB1J332J	CHIP R 3.3K J 1/16W	
R100,101			RK73HB1J472J	CHIP R 4.7K J 1/16W		R221		*	RK73HH1J332D	CHIP R 3.3K D 1/16W	
R102			RK73HB1J473J	CHIP R 47K J 1/16W		R222			RK73HB1J220J	CHIP R 22 J 1/16W	
R103			RK73HB1J331J	CHIP R 330 J 1/16W		R223			RK73HB1J184J	CHIP R 180K J 1/16W	
						R226			RK73HB1J221J	CHIP R 220 J 1/16W	

PARTS LIST

TX-RX UNIT (X57-641X-XX)

Ref. No.	Address	New parts	Parts No.	Description	Destination	Ref. No.	Address	New parts	Parts No.	Description	Destination
R227,228			RK73HB1J331J	CHIP R 330 J 1/16W		R327			RK73HB1J473J	CHIP R 47K J 1/16W	
R229			RK73HB1J472J	CHIP R 4.7K J 1/16W		R330			RK73HB1J184J	CHIP R 180K J 1/16W	
R230			RK73HB1J000J	CHIP R 0.0 J 1/16W		R333			RK73HB1J473J	CHIP R 47K J 1/16W	
R232			RK73HB1J102J	CHIP R 1.0K J 1/16W	E3	R334			RK73HB1J184J	CHIP R 180K J 1/16W	
						R336			RK73HB1J223J	CHIP R 22K J 1/16W	
R232			RK73HB1J472J	CHIP R 4.7K J 1/16W	E	R337,338			RK73HB1J473J	CHIP R 47K J 1/16W	
R233			RK73HB1J151J	CHIP R 150 J 1/16W		R339-341			RK73HB1J103J	CHIP R 10K J 1/16W	
R234			RK73HB1J104J	CHIP R 100K J 1/16W		R342			RK73HB1J223J	CHIP R 22K J 1/16W	
R235			RK73HB1J563J	CHIP R 56K J 1/16W		R343			RK73HB1J103J	CHIP R 10K J 1/16W	
R236			RK73HB1J104J	CHIP R 100K J 1/16W		R344,345			RK73HB1J000J	CHIP R 0.0 J 1/16W	
R237			RK73HB1J563J	CHIP R 56K J 1/16W		R346			RK73HB1J473J	CHIP R 47K J 1/16W	
R238			RK73HB1J000J	CHIP R 0.0 J 1/16W		R347			RK73HB1J102J	CHIP R 1.0K J 1/16W	
R239-241			RK73HB1J105J	CHIP R 1.0M J 1/16W		R348			RK73HB1J472J	CHIP R 4.7K J 1/16W	
R243			RK73HB1J221J	CHIP R 220 J 1/16W		R349,350			RK73HB1J473J	CHIP R 47K J 1/16W	
R244			RK73HB1J104J	CHIP R 100K J 1/16W		R351			RK73HB1J000J	CHIP R 0.0 J 1/16W	
R246			RK73HB1J104J	CHIP R 100K J 1/16W		R352,353			RK73HB1J102J	CHIP R 1.0K J 1/16W	
R247			RK73HB1J683J	CHIP R 68K J 1/16W		R354			RK73HB1J000J	CHIP R 0.0 J 1/16W	
R248,249			RK73HB1J105J	CHIP R 1.0M J 1/16W		R356			RK73HB1J473J	CHIP R 47K J 1/16W	
R250			RK73HB1J102J	CHIP R 1.0K J 1/16W		R357			RK73HB1J471J	CHIP R 470 J 1/16W	
R252			RK73HB1J470J	CHIP R 47 J 1/16W		R359			RK73HB1J153J	CHIP R 15K J 1/16W	
R253			RK73GB2A000JX	CHIP R 0.0 J 1/10W		R360			RK73HB1J182J	CHIP R 1.8K J 1/16W	
R254			RK73HB1J470J	CHIP R 47 J 1/16W		R361			RK73HB1J102J	CHIP R 1.0K J 1/16W	
R255			RK73HB1J272D	CHIP R 2.7K D 1/16W		R362			RK73HB1J473J	CHIP R 47K J 1/16W	
R256			RK73HB1J473J	CHIP R 47K J 1/16W		R363			RK73HB1J124J	CHIP R 120K J 1/16W	
R259			RK73HB1J684J	CHIP R 680K J 1/16W		R364			RK73HB1J104J	CHIP R 100K J 1/16W	
R260			RK73HB1J184J	CHIP R 180K J 1/16W		R365			RK73HB1J473J	CHIP R 47K J 1/16W	
R264			RK73HB1J181J	CHIP R 180 J 1/16W		R366			RK73HB1J102J	CHIP R 1.0K J 1/16W	
R265			RK73HB1J564J	CHIP R 560K J 1/16W		R367			RK73HB1J103J	CHIP R 10K J 1/16W	
R266			RK73HB1J272J	CHIP R 2.7K J 1/16W		R368			RK73HB1J102J	CHIP R 1.0K J 1/16W	
R267			RK73HB1J334J	CHIP R 330K J 1/16W		R369			RK73HB1J563J	CHIP R 56K J 1/16W	
R268			RK73HB1J221J	CHIP R 220 J 1/16W		R370			RK73HB1J104J	CHIP R 100K J 1/16W	
R270			RK73FB2B000JX	CHIP R 0.0 J 1/8W		R371			RK73HB1J272J	CHIP R 2.7K J 1/16W	
R273			RK73HB1J000J	CHIP R 0.0 J 1/16W		R372			RK73HB1J000J	CHIP R 0.0 J 1/16W	
R276			RK73HB1J000J	CHIP R 0.0 J 1/16W		R373			RK73HB1J124J	CHIP R 120K J 1/16W	
R300,301			RK73HB1J104J	CHIP R 100K J 1/16W		R374			RK73HB1J104J	CHIP R 100K J 1/16W	
R302			RK73HB1J393J	CHIP R 39K J 1/16W		R376			RK73HB1J103J	CHIP R 10K J 1/16W	
R303			RK73HB1J684J	CHIP R 680K J 1/16W		R377			RK73HB1J104J	CHIP R 100K J 1/16W	
R304			RK73HB1J394J	CHIP R 390K J 1/16W		R378			RK73HB1J101J	CHIP R 100 J 1/16W	
R308			RK73HB1J332J	CHIP R 3.3K J 1/16W		R379			RK73HB1J821J	CHIP R 820 J 1/16W	
R309			RK73HB1J000J	CHIP R 0.0 J 1/16W		R380,381			RK73HB1J101J	CHIP R 100 J 1/16W	
R310			RK73HB1J473J	CHIP R 47K J 1/16W		R382			RK73HB1J103J	CHIP R 10K J 1/16W	
R311			RK73HB1J104J	CHIP R 100K J 1/16W		R383			RK73HB1J101J	CHIP R 100 J 1/16W	
R312			RK73HB1J224J	CHIP R 220K J 1/16W		R384			RK73HB1J331J	CHIP R 330 J 1/16W	
R313			RK73HB1J000J	CHIP R 0.0 J 1/16W		R385			RK73HB1J470J	CHIP R 47 J 1/16W	
R314			RK73HB1J101J	CHIP R 100 J 1/16W		R386			RK73HB1J331J	CHIP R 330 J 1/16W	
R315			RK73HB1J105D	CHIP R 1.0M D 1/16W		R388			RK73HB1J474J	CHIP R 470K J 1/16W	
R316			RK73HB1J104J	CHIP R 100K J 1/16W		R389			RK73HB1J472J	CHIP R 4.7K J 1/16W	
R317			RK73HB1J184J	CHIP R 180K J 1/16W		R390			RK73HB1J821J	CHIP R 820 J 1/16W	
R318			RK73HB1J393J	CHIP R 39K J 1/16W	E3	R391,392			RK73HB1J331J	CHIP R 330 J 1/16W	
R318			RK73HB1J683J	CHIP R 68K J 1/16W	E	R397,398			RK73HB1J000J	CHIP R 0.0 J 1/16W	
R319			RK73HB1J473J	CHIP R 47K J 1/16W		R400			RK73HB1J103J	CHIP R 10K J 1/16W	
R320			RK73HB1J563J	CHIP R 56K J 1/16W		R401,402			RK73HB1J474D	CHIP R 470K D 1/16W	
R320			RK73HB1J683J	CHIP R 68K J 1/16W	E3	R403			RK73HB1J334J	CHIP R 330K J 1/16W	
R321			RK73HB1J394J	CHIP R 390K J 1/16W	E	R404			RK73HB1J105J	CHIP R 1.0M J 1/16W	
R321			RK73HB1J564J	CHIP R 560K J 1/16W	E3	R405			RK73GB2A000JX	CHIP R 0.0 J 1/10W	
R322			RK73HB1J154J	CHIP R 150K J 1/16W		R406			RK73HB1J103J	CHIP R 10K J 1/16W	
R323			RK73HB1J823J	CHIP R 82K J 1/16W		R407			RK73HB1J224J	CHIP R 220K J 1/16W	
R324			RK73HB1J474J	CHIP R 470K J 1/16W		R408			RK73HB1J103J	CHIP R 10K J 1/16W	
R325			RK73HB1J364J	CHIP R 360K J 1/16W		R410			RK73HB1J102J	CHIP R 1.0K J 1/16W	
R326			RK73HB1J000J	CHIP R 0.0 J 1/16W		R411			RK73HB1J471J	CHIP R 470 J 1/16W	

PARTS LIST

TX-RX UNIT (X57-641X-XX)

Ref. No.	Address	New parts	Parts No.	Description	Destination	Ref. No.	Address	New parts	Parts No.	Description	Destination
R413			RK73HB1J105J	CHIP R 1.0M J 1/16W		R815			RK73HB1J103J	CHIP R 10K J 1/16W	
R414			RK73HB1J103J	CHIP R 10K J 1/16W		R817			RK73HB1J101J	CHIP R 100 J 1/16W	E3
R500			RK73HH1J105D	CHIP R 1.0M D 1/16W		R817			RK73HB1J102J	CHIP R 1.0K J 1/16W	E
R501			RK73HB1J333J	CHIP R 33K J 1/16W		R818			RK73HB1J154J	CHIP R 150K J 1/16W	
R502			RK73HB1J334J	CHIP R 330K J 1/16W		R819			RK73HB1J473J	CHIP R 47K J 1/16W	
R503			RK73HB1J154J	CHIP R 150K J 1/16W		R820			RK73HB1J000J	CHIP R 0.0 J 1/16W	
R504			RK73HB1J184J	CHIP R 180K J 1/16W		R824,825			RK73HB1J102J	CHIP R 1.0K J 1/16W	
R505			RK73HB1J000J	CHIP R 0.0 J 1/16W		R826			RK73HB1J000J	CHIP R 0.0 J 1/16W	
R506			RK73HH1J105D	CHIP R 1.0M D 1/16W		R828			RK73HB1J000J	CHIP R 0.0 J 1/16W	
R507			RK73HB1J124J	CHIP R 120K J 1/16W		R901			RK73HB1J103J	CHIP R 10K J 1/16W	
R508			RK73HB1J224J	CHIP R 220K J 1/16W		R902,903			RK73HB1J473J	CHIP R 47K J 1/16W	
R509			RK73HB1J000J	CHIP R 0.0 J 1/16W		R904			RK73HB1J560J	CHIP R 56 J 1/16W	E
R510			RK73HH1J105D	CHIP R 1.0M D 1/16W		R905			RK73HB1J000J	CHIP R 0.0 J 1/16W	E3
R511			RK73HB1J153J	CHIP R 15K J 1/16W		R906-908			RK73HB1J472J	CHIP R 4.7K J 1/16W	
R512			RK73HB1J124J	CHIP R 120K J 1/16W		R909			RK73HB1J000J	CHIP R 0.0 J 1/16W	
R513			RK73HB1J153J	CHIP R 15K J 1/16W		R910,911			RK73HB1J103J	CHIP R 10K J 1/16W	
R514			RK73HB1J000J	CHIP R 0.0 J 1/16W		R912			RK73HB1J332J	CHIP R 3.3K J 1/16W	
R515,516			RK73HB1J124J	CHIP R 120K J 1/16W		R913			RK73HB1J103J	CHIP R 10K J 1/16W	
R517			RK73HB1J273J	CHIP R 27K J 1/16W		R914,915			RK73HB1J683J	CHIP R 68K J 1/16W	
R518			RK73HB1J114J	CHIP R 110K J 1/16W		R916			RK73HB1J823J	CHIP R 82K J 1/16W	
R519			RK73HB1J472J	CHIP R 4.7K J 1/16W		R917			RK73HB1J124J	CHIP R 120K J 1/16W	E3
R520,521			RK73HB1J394J	CHIP R 390K J 1/16W		R917			RK73HB1J683J	CHIP R 68K J 1/16W	E
R522			RK73HB1J473J	CHIP R 47K J 1/16W		R918-920			RK73HB1J103J	CHIP R 10K J 1/16W	
R523			RK73HB1J684J	CHIP R 680K J 1/16W		S600-602			S70-0457-05	TACT SWITCH(PTT,SW1,SW2)	
R524			RK73HB1J154J	CHIP R 150K J 1/16W		D1 -4			1SV325F	VARIABLE CAPACITANCE DIODE	
R527			RK73HB1J474J	CHIP R 470K J 1/16W		D5			1SV278F	VARIABLE CAPACITANCE DIODE	
R528-534			RK73HB1J472J	CHIP R 4.7K J 1/16W		D6			MA2S111-F	DIODE	
R535			RK73HH1J105D	CHIP R 1.0M D 1/16W		D100-105			HVC131	DIODE	E3
R536			RK73HB1J104J	CHIP R 100K J 1/16W		D100,101			HSC277	DIODE	E
R537			RK73HB1J103J	CHIP R 10K J 1/16W		D102-105			HVC131	DIODE	E
R538			RK73HB1J272J	CHIP R 2.7K J 1/16W		D106			HZU5CLL	ZENER DIODE	
R539			RK73HB1J102J	CHIP R 1.0K J 1/16W		D200			HVC131	DIODE	
R540			RK73HB1J000J	CHIP R 0.0 J 1/16W		D201			RB706F-40	DIODE	
R541			RK73HB1J114J	CHIP R 110K J 1/16W		D202,203			DAN235E	DIODE	
R542			RK73HB1J123J	CHIP R 12K J 1/16W		D204-208			HVC369B	VARIABLE CAPACITANCE DIODE	
R543,544			RK73HB1J472J	CHIP R 4.7K J 1/16W		D209			MA2S111-F	DIODE	
R545-547			RK73HB1J000J	CHIP R 0.0 J 1/16W		D300			RB706F-40	DIODE	
R548			RK73HB1J184J	CHIP R 180K J 1/16W		D301			1SS373F	DIODE	
R549			RK73HB1J472J	CHIP R 4.7K J 1/16W		D302			DA221	DIODE	
R550			RK73HB1J153J	CHIP R 15K J 1/16W		D303,304			015AZ6.8F	ZENER DIODE	
R603-611			RK73HB1J471J	CHIP R 470 J 1/16W		D305			015AZ2.4(X)F	ZENER DIODE	
R612,613			RK73HB1J000J	CHIP R 0.0 J 1/16W		D306			DA221	DIODE	
R614,615			RK73HB1J473J	CHIP R 47K J 1/16W		D307			015AZ6.8F	ZENER DIODE	
R617,618			RK73HB1J473J	CHIP R 47K J 1/16W		D308			NNCD6.8G-A	ZENER DIODE	
R619			RK73HB1J000J	CHIP R 0.0 J 1/16W		D402			1SR154-400	DIODE	
R620			RK73HB1J473J	CHIP R 47K J 1/16W		D403			MA2S111-F	DIODE	
R621			RK73HB1J000J	CHIP R 0.0 J 1/16W		D405			RB521S-30	DIODE	
R623			RK73HB1J000J	CHIP R 0.0 J 1/16W		D500,501			HSM88AS-E	DIODE	
R624			RK73HB1J102J	CHIP R 1.0K J 1/16W		D801			MA2S111-F	DIODE	
R740			RK73HB1J473J	CHIP R 47K J 1/16W		D902,903			DAN235E	DIODE	
R801			RK73HB1J102J	CHIP R 1.0K J 1/16W		IC100			TA75W01FUF	MOS-IC	
R806			RK73HB1J124J	CHIP R 120K J 1/16W	E3	IC200			TA31136FNG	MOS-IC	
R807			RK73HB1J100J	CHIP R 10 J 1/16W	E	IC201			TC75W51FUF	MOS-IC	
R809			RK73HB1J000J	CHIP R 0.0 J 1/16W	E3	IC302-304			TC75W51FUF	MOS-IC	
R811			RK73HB1J000J	CHIP R 0.0 J 1/16W	E	IC305			TC75W51FK(F)	MOS-IC	
R812			RK73HB1J222J	CHIP R 2.2K J 1/16W		IC306			TC75W51FUF	MOS-IC	
R812			RK73HB1J472J	CHIP R 4.7K J 1/16W		IC307			M62364FP-F	MOS-IC	
R813			RK73HB1J152J	CHIP R 1.5K J 1/16W		IC308			AT29C02090TU	ROM IC	
R813			RK73HB1J822J	CHIP R 8.2K J 1/16W							
R814			RK73HB1J000J	CHIP R 0.0 J 1/16W							

PARTS LIST

TX-RX UNIT (X57-641X-XX)

Ref. No.	Address	New parts	Parts No.	Description	Destination	Ref. No.	Address	New parts	Parts No.	Description	Destination
IC309		*	30620M8A2W6GPU	MPU		Q902			2SJ243-A	FET	
IC310			AT24C16A10SU18	ROM IC		Q903			DTC144EE	DIGITAL TRANSISTOR	
IC311,312			BU4094BCFV	MOS-IC							
IC313			TDA7053AT	BI-POLAR IC		TH1			ERTJ0EV104H	THERMISTOR	
IC400			XC61CN4202NR	MOS-IC		TH200			ERTJ0EV104H	THERMISTOR	
IC401		*	XC6204B502MR	MOS-IC		TH300			TN10-3S154JT	THERMISTOR	
IC402			XC62GR5012PR	MOS-IC		TH901,902			ERTJ0EV104H	THERMISTOR	
IC403		*	XC6204B502MR	MOS-IC							
IC404			XC61CN5002NR	MOS-IC							
IC500			LC73872M	MOS-IC							
IC501			AK2346	MOS-IC							
IC502			TC75S51F-F	MOS-IC							
IC801			LMX2316TMX	MOS-IC							
IC901			TC75S51FE(F)	MOS-IC							
Q2 ,3			2SK508NV(K52)	FET							
Q4			2SJ347F	FET							
Q5			2SC5108(Y)F	TRANSISTOR							
Q6			RN47A4-F	TRANSISTOR							
Q7			2SC4617(S)	TRANSISTOR							
Q8			2SC5108(Y)F	TRANSISTOR							
Q100			2SC5108(Y)F	TRANSISTOR							
Q101			2SC5192-A	TRANSISTOR							
Q103			2SK2596	FET							
Q104,105			DTC114EE	DIGITAL TRANSISTOR							
Q106			2SK3476-F	FET							
Q107			2SK1824-A	FET							
Q108			DTA144EE	DIGITAL TRANSISTOR							
Q201			DTC144EE	DIGITAL TRANSISTOR							
Q202			RN47A4-F	TRANSISTOR							
Q203			2SK1824-A	FET							
Q204			2SK1830F	FET							
Q205			2SC5108(Y)F	TRANSISTOR							
Q206,207			3SK318	FET							
Q208			2SC4617(S)	TRANSISTOR							
Q300			2SC4649(N,P)	TRANSISTOR							
Q301			2SJ347F	FET							
Q302			2SC4617(S)	TRANSISTOR							
Q303			2SB1132(Q,R)	TRANSISTOR							
Q304			2SC4617(S)	TRANSISTOR							
Q305			UPA672T-A	FET							
Q306			2SC4617(S)	TRANSISTOR							
Q307			UPA672T-A	FET							
Q308			2SK1824-A	FET							
Q309,310			2SC4617(S)	TRANSISTOR							
Q311		*	2SA1362-F(Y)	TRANSISTOR							
Q400			2SJ347F	FET							
Q401			2SK1830F	FET							
Q403			DTC144EE	DIGITAL TRANSISTOR							
Q404			2SJ347F	FET							
Q405			KTA2015(Y)	TRANSISTOR							
Q406			2SJ347F	FET							
Q500,501			2SJ243-A	FET							
Q502			2SC4116(Y)F	TRANSISTOR							
Q504			2SA1586(Y,GR)F	TRANSISTOR							
Q505			DTA114EE	DIGITAL TRANSISTOR							
Q506			2SK1824-A	FET							
Q507			2SJ243-A	FET							
Q803			2SC5108(Y)F	TRANSISTOR							
Q901			2SK1824-A	FET							

TK-3140 PC BOARD

TX-RX UNIT (X57-641X-XX) (A/3) 2-71 : E, 2-72 : E3
Component side view (J79-0058-09 A/3)

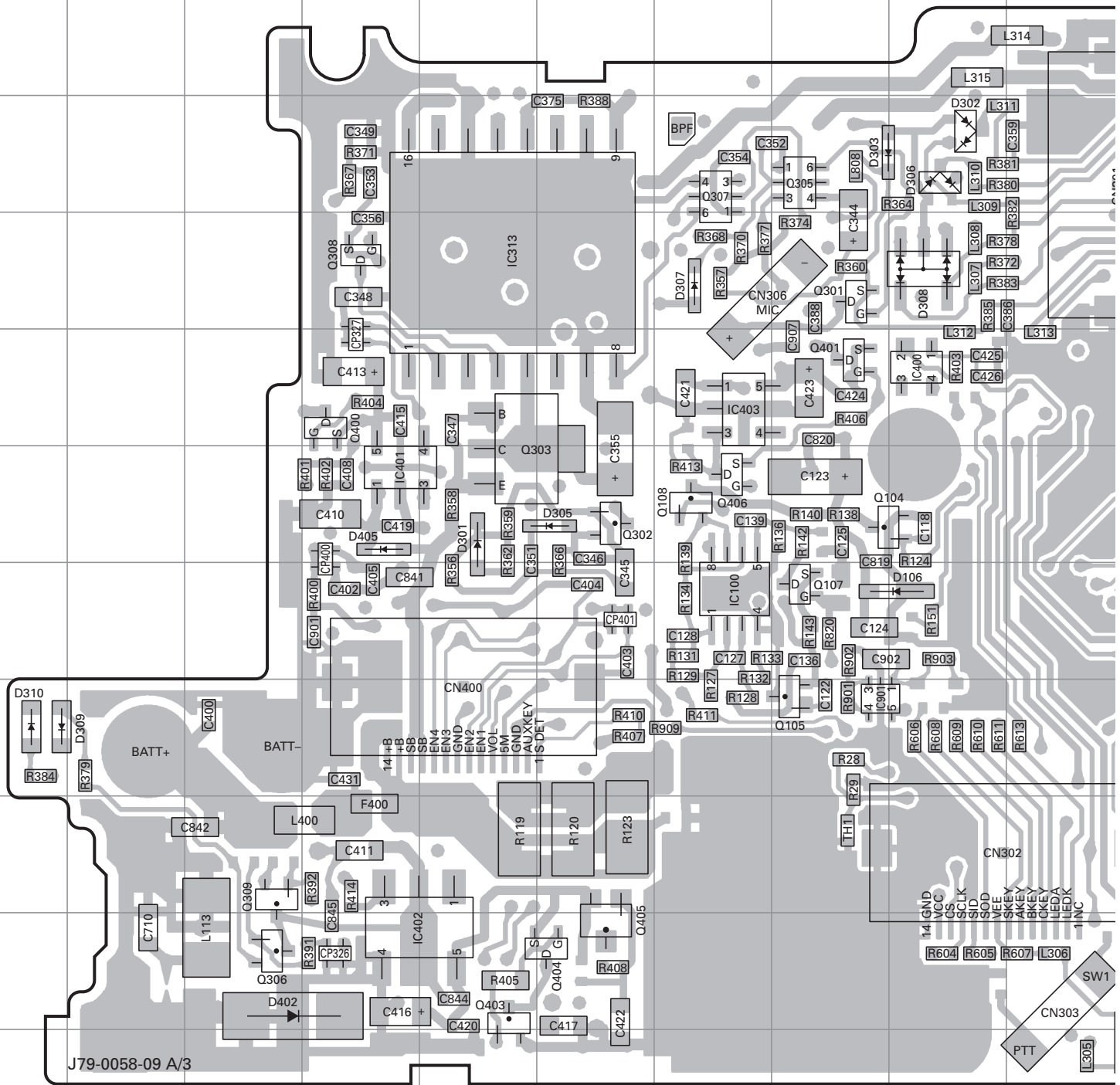

Ref. No.	Address	Ref. No.	Address	Ref. No.	Address	Ref. No.	Address	Ref. No.	Address	Ref. No.	Address
IC100	7G	IC400	5I	Q300	10N	Q309	9C	D106	7I	D308	4I
IC302	8L	IC401	6D	Q301	4H	Q310	9L	D300	5L	D309	8A
IC303	4L	IC402	10D	Q302	6F	Q311	9L	D301	6E	D310	8A
IC308	4O	IC403	5G	Q303	6E	Q400	5D	D302	3I	D402	10C
IC309	8P	IC901	8H	Q304	11K	Q401	5H	D303	3H	D405	6D
IC310	10P	Q104	6H	Q305	3H	Q403	10E	D304	4L		
IC311	3N	Q105	8H	Q306	10C	Q404	10F	D305	6F		
IC312	3P	Q107	7H	Q307	3G	Q405	10F	D306	3I		
IC313	4E	Q108	6G	Q308	4D	Q406	6G	D307	4G		

TK-3140 PC BOARD

TX-RX UNIT (X57-641X-XX) (A/3) 2-71 : E, 2-72 : E3
Component side view (J79-0058-09 A/3)

PC BOARD TK-3140

TX-RX UNIT (X57-641X-XX) (A/3) 2-71 : E, 2-72 : E3
Component side view (J79-0058-09 A/3)

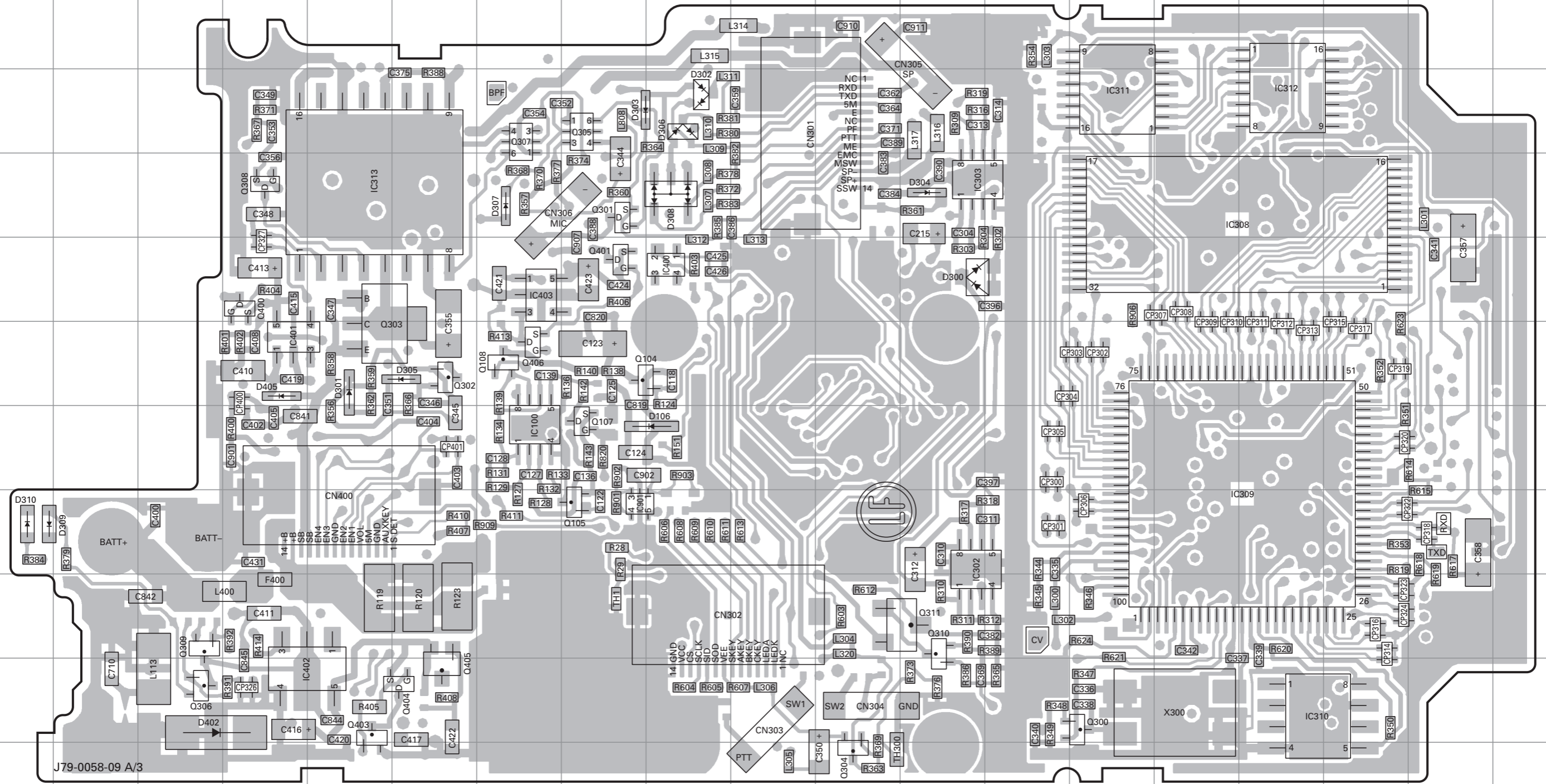

Ref. No.	Address	Ref. No.	Address	Ref. No.	Address	Ref. No.	Address	Ref. No.	Address	Ref. No.	Address
IC100	7G	IC400	5I	Q300	10N	Q309	9C	D106	7I	D308	4I
IC302	8L	IC401	6D	Q301	4H	Q310	9L	D300	5L	D309	8A
IC303	4L	IC402	10D	Q302	6F	Q311	9L	D301	6E	D310	8A
IC308	4O	IC403	5G	Q303	6E	Q400	5D	D302	3I	D402	10C
IC309	8P	IC901	8H	Q304	11K	Q401	5H	D303	3H	D405	6D
IC310	10P	Q104	6H	Q305	3H	Q403	10E	D304	4L		
IC311	3N	Q105	8H	Q306	10C	Q404	10F	D305	6F		
IC312	3P	Q107	7H	Q307	3G	Q405	10F	D306	3I		
IC313	4E	Q108	6G	Q308	4D	Q406	6G	D307	4G		

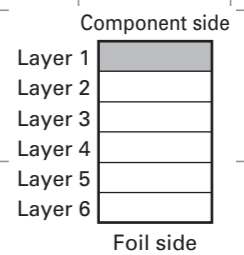

J79-0058-09 A/3

TK-3140 PC BOARD

TX-RX UNIT (X57-641X-XX) (A/3) 2-71 : E, 2-72 : E3

Foil side view (J79-0058-09 A/3)

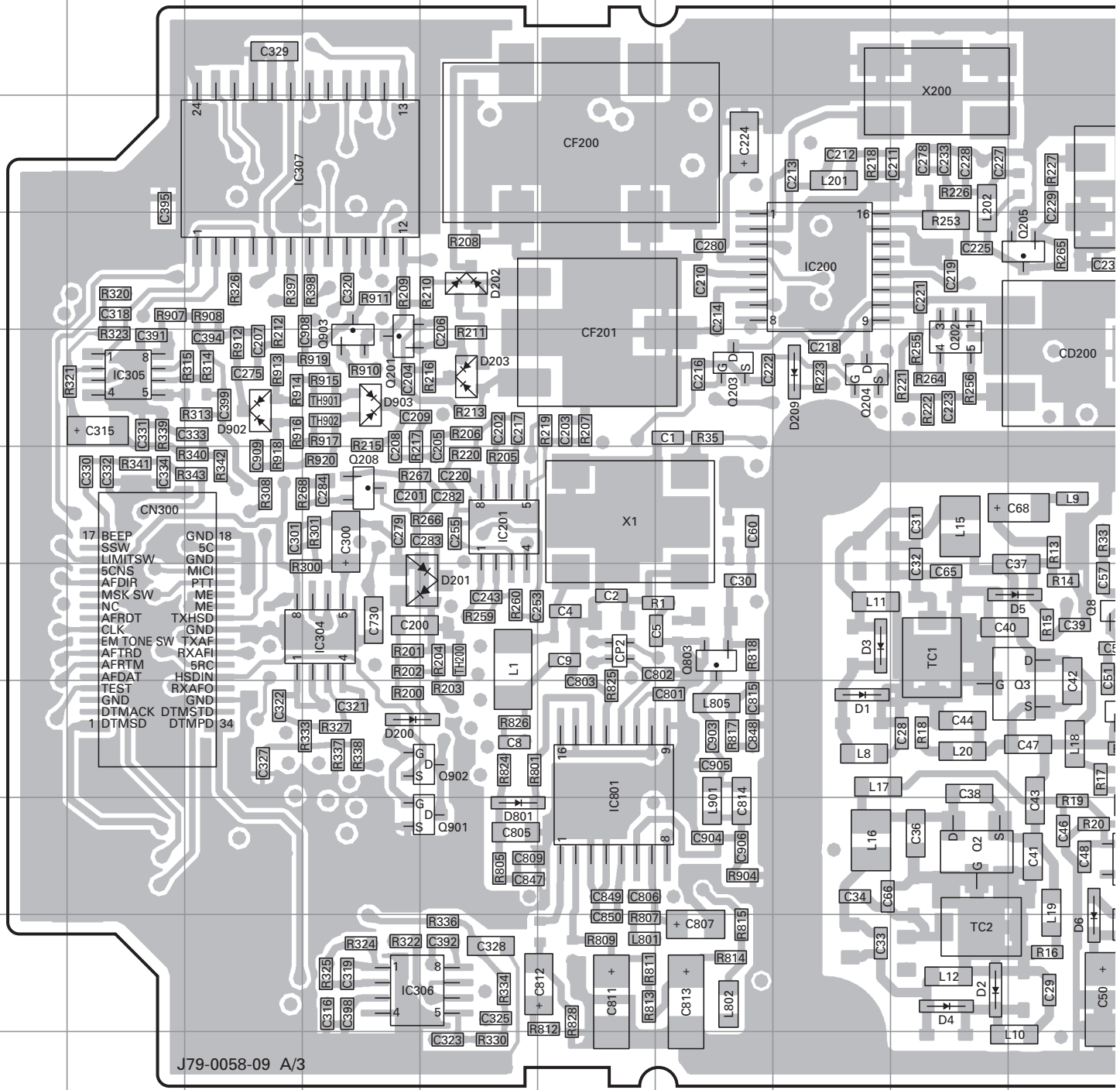

J79-0058-09 A/3

Ref. No.	Address	Ref. No.	Address	Ref. No.	Address	Ref. No.	Address	Ref. No.	Address	Ref. No.	Address	Ref. No.	Address
IC200	4H	Q3	8J	Q106	10M	Q803	7G	D6	10J	D202	4E	D801	9E
IC201	6E	Q4	9K	Q201	5D	Q901	9E	D100	5K	D203	5E	D902	5C
IC304	7D	Q5	8K	Q202	5I	Q902	8E	D101	5K	D204	4O	D903	5D
IC305	5B	Q6	9K	Q203	5G	Q903	5D	D102	9P	D205	4O		
IC306	10D	Q7	10K	Q204	5H	D1	8H	D103	9P	D206	5N		
IC307	3C	Q8	7J	Q205	4J	D2	10I	D104	9P	D207	7N		
IC404	7P	Q100	5M	Q206	4M	D3	7H	D105	8P	D208	8N		
IC801	8F	Q101	6M	Q207	6O	D4	10I	D200	8D	D209	5H		
Q2	9I	Q103	7L	Q208	6D	D5	7J	D201	7E	D403	5P		

PC BOARD TK-3140

TX-RX UNIT (X57-641X-XX) (A/3) 2-71 : E, 2-72 : E3

Foil side view (J79-0058-09 A/3)

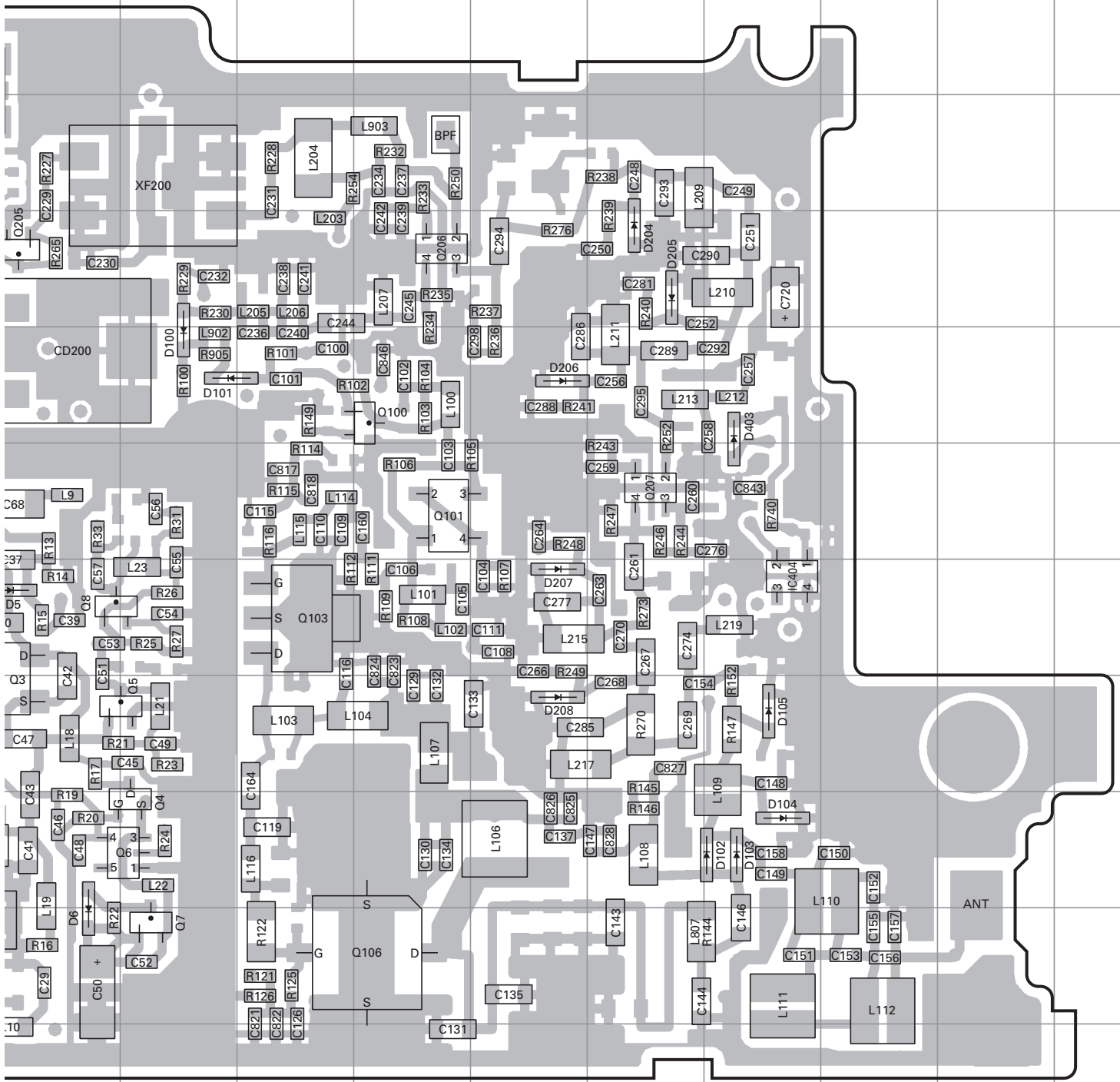

Component side

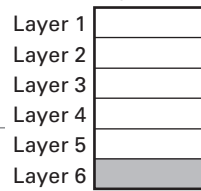

Foil side

TK-3140 PC BOARD

TX-RX UNIT (X57-641X-XX) (A/3) 2-71 : E, 2-72 : E3
Foil side view (J79-0058-09 A/3)

PC BOARD TK-3140

TX-RX UNIT (X57-641X-XX) (A/3) 2-71 : E, 2-72 : E3
Foil side view (J79-0058-09 A/3)

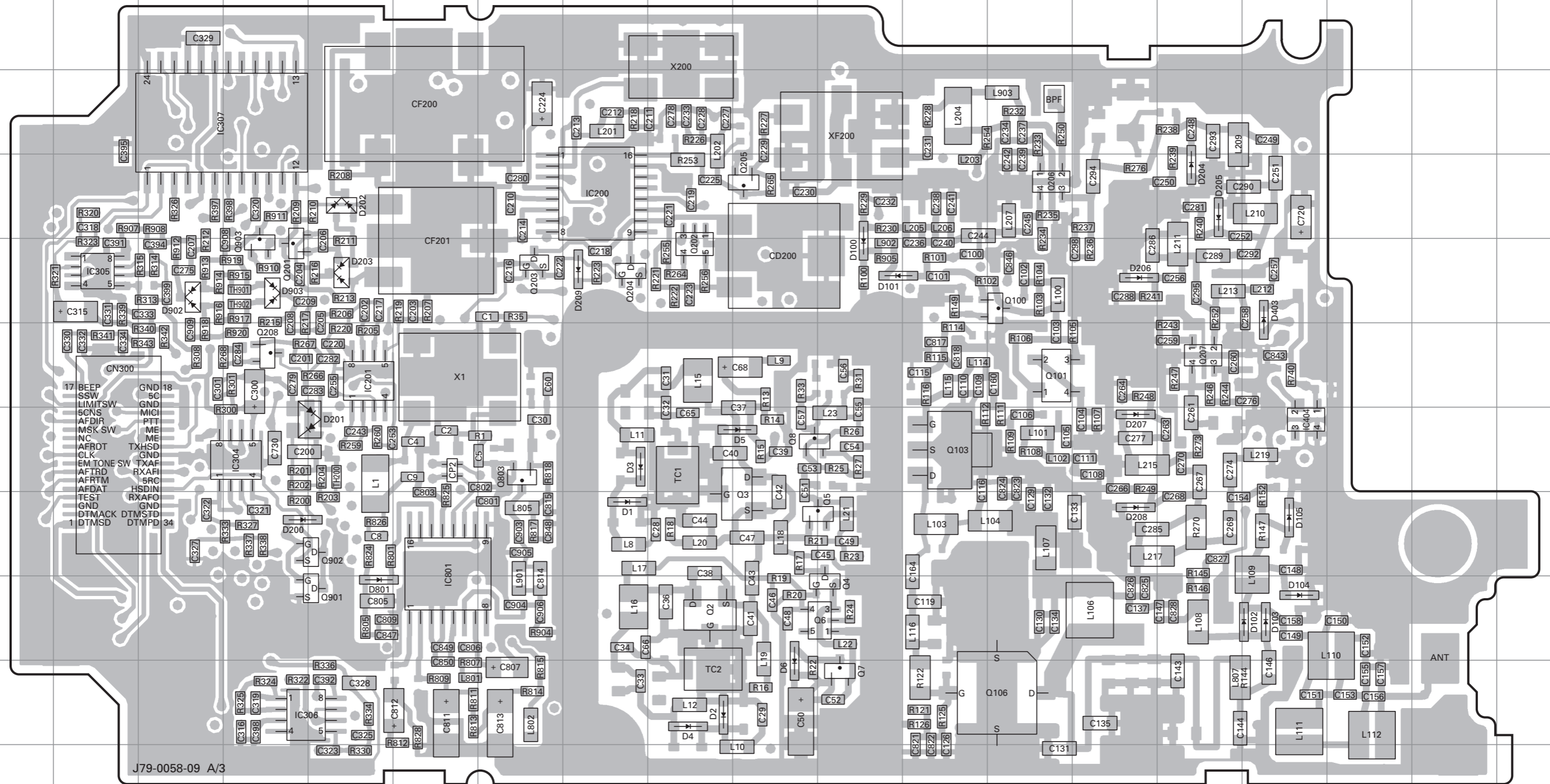

J79-0058-09 A/3

ANT

Ref. No.	Address	Ref. No.	Address	Ref. No.	Address	Ref. No.	Address	Ref. No.	Address	Ref. No.	Address	Ref. No.	Address
IC200	4H	Q3	8J	Q106	10M	Q803	7G	D6	10J	D202	4E	D801	9E
IC201	6E	Q4	9K	Q201	5D	Q901	9E	D100	5K	D203	5E	D902	5C
IC304	7D	Q5	8K	Q202	5I	Q902	8E	D101	5K	D204	4O	D903	5D
IC305	5B	Q6	9K	Q203	5G	Q903	5D	D102	9P	D205	4O		
IC306	10D	Q7	10K	Q204	5H	D1	8H	D103	9P	D206	5N		
IC307	3C	Q8	7J	Q205	4J	D2	10I	D104	9P	D207	7N		
IC404	7P	Q100	5M	Q206	4M	D3	7H	D105	8P	D208	8N		
IC801	8F	Q101	6M	Q207	6O	D4	10I	D200	8D	D209	5H		
Q2	9I	Q103	7L	Q208	6D	D5	7J	D201	7E	D403	5P		

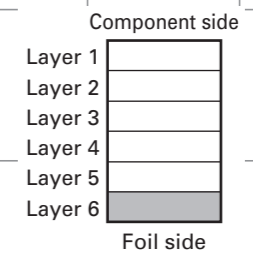

TK-3140 PC BOARD

TX-RX UNIT (X57-641X-XX) (B/3) 2-71 : E, 2-72 : E3
Component side view (J79-0058-09 B/3)

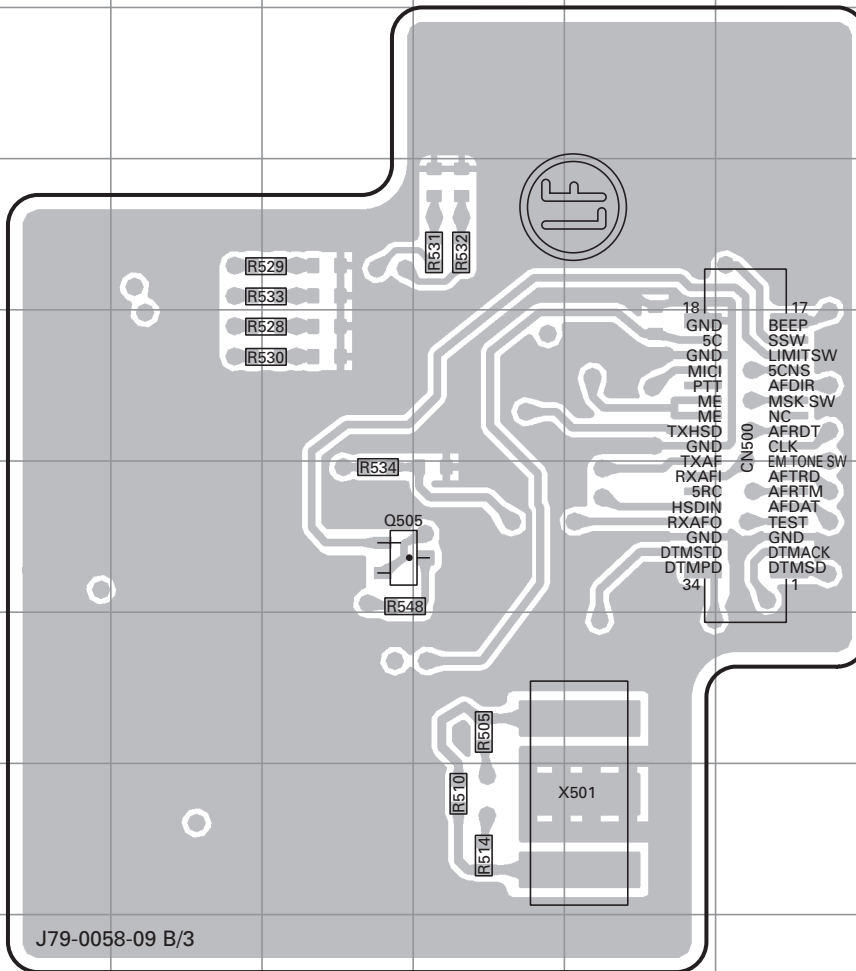

Ref. No.	Address
Q505	6D

- 18 GND
- 5C
- GND
- MIC1
- PTT
- ME
- ME
- TXHSD
- GND
- TXAF
- RXAFL
- 5RC
- HSDIN
- RXAFO
- GND
- DTMSTD
- DTMPD
- 34
- 17 BEEP
- SSW
- LIMITSW
- 5CNS
- AFDIR
- MSK SW
- NC
- AFRDT
- CLK
- EM TONE SW
- AFRDM
- AFDAT
- TEST
- GND
- DTMACK
- DTMSD
- 1

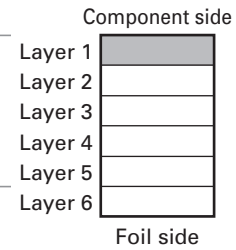

TX-RX UNIT (X57-641X-XX) (C/3) 2-71 : E, 2-72 : E3
Component side view (J79-0058-09 C/3)

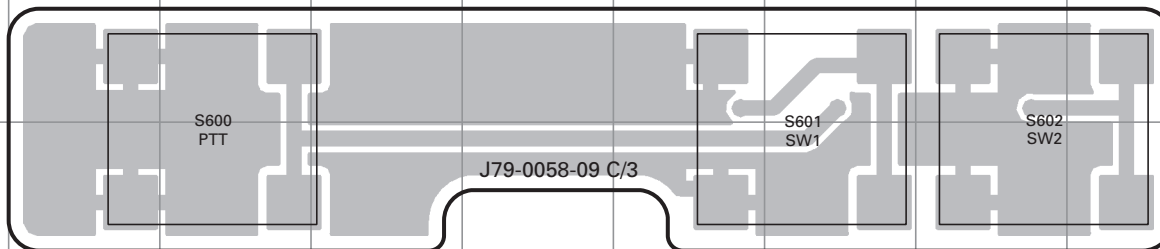

PC BOARD TK-3140

TX-RX UNIT (X57-641X-XX) (B/3) 2-71 : E, 2-72 : E3 Foil side view (J79-0058-09 B/3)

Ref. No.	Address
IC500	8F
IC501	5G
IC502	7H
Q500	6E
Q501	4I
Q502	8G
Q504	8G
Q506	6E
Q507	5E
D500	8I
D501	8I

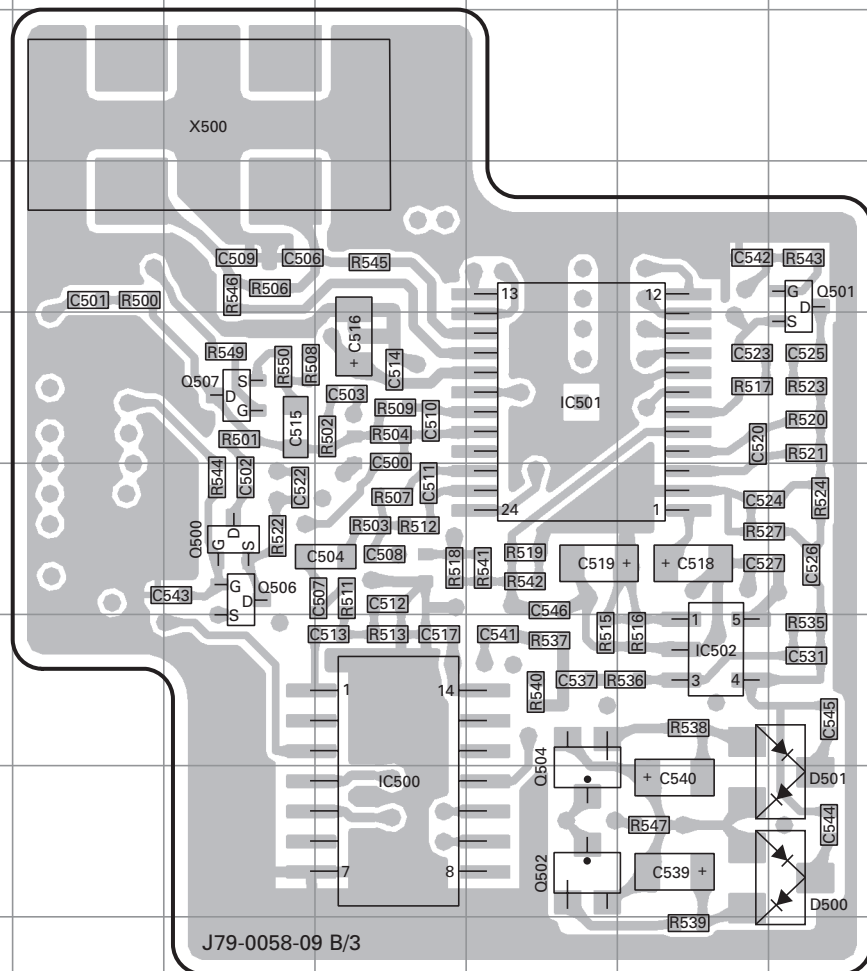
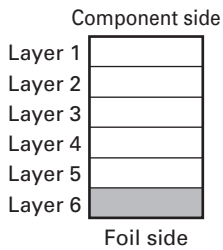

TX-RX UNIT (X57-641X-XX) (C/3) 2-71 : E, 2-72 : E3 Foil side view (J79-0058-09 C/3)

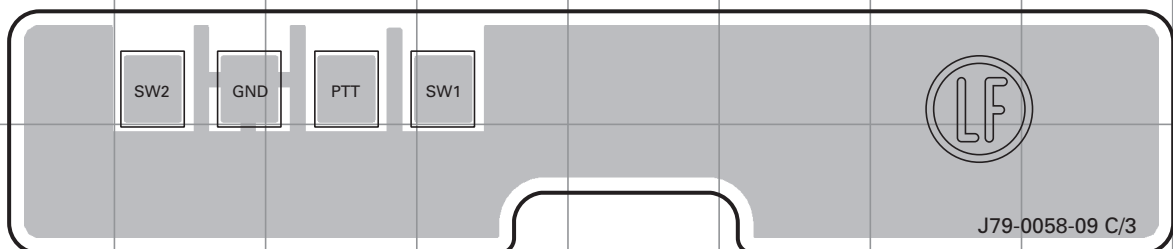

TK-3140 SCHEMATIC DIAGRAM

TX-RX UNIT(X57-641X-XX)(A/3)

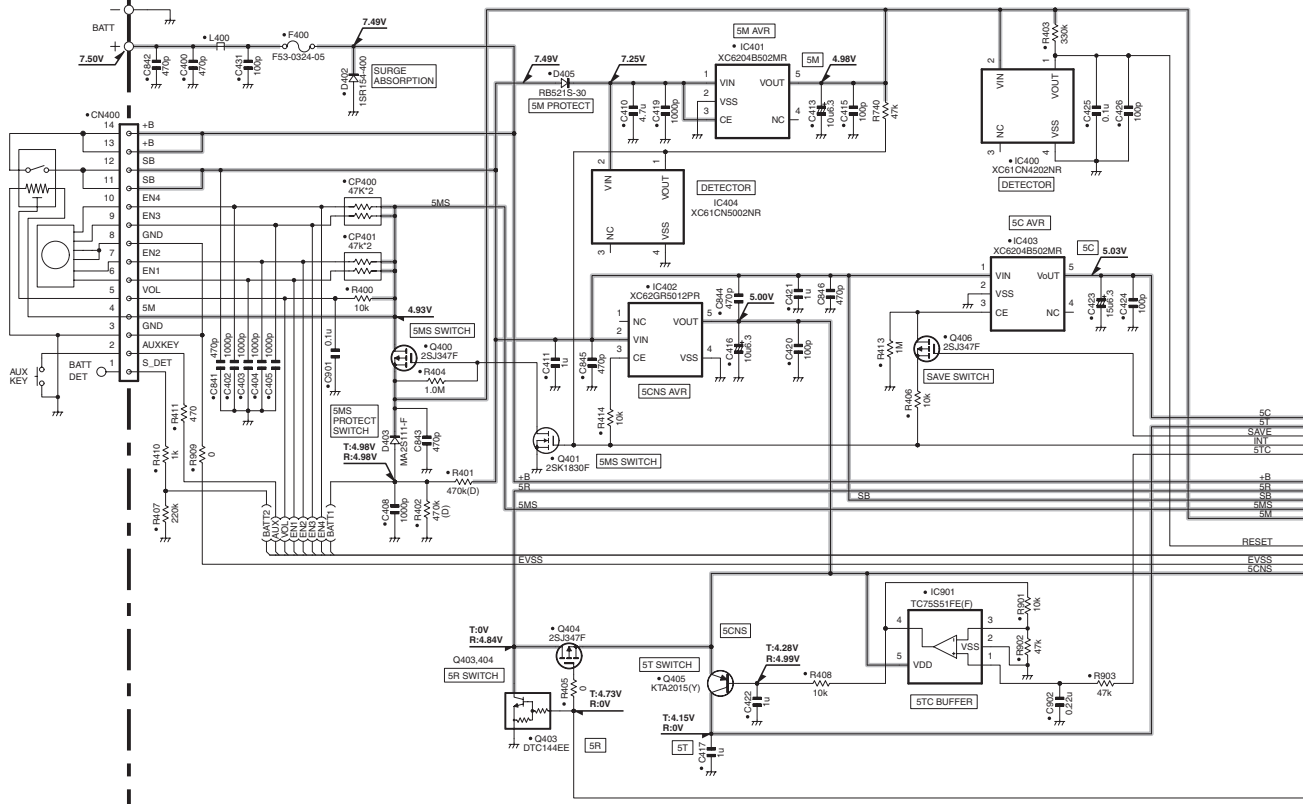

TX-RX UNIT(X57-6412-XX)(B/3)

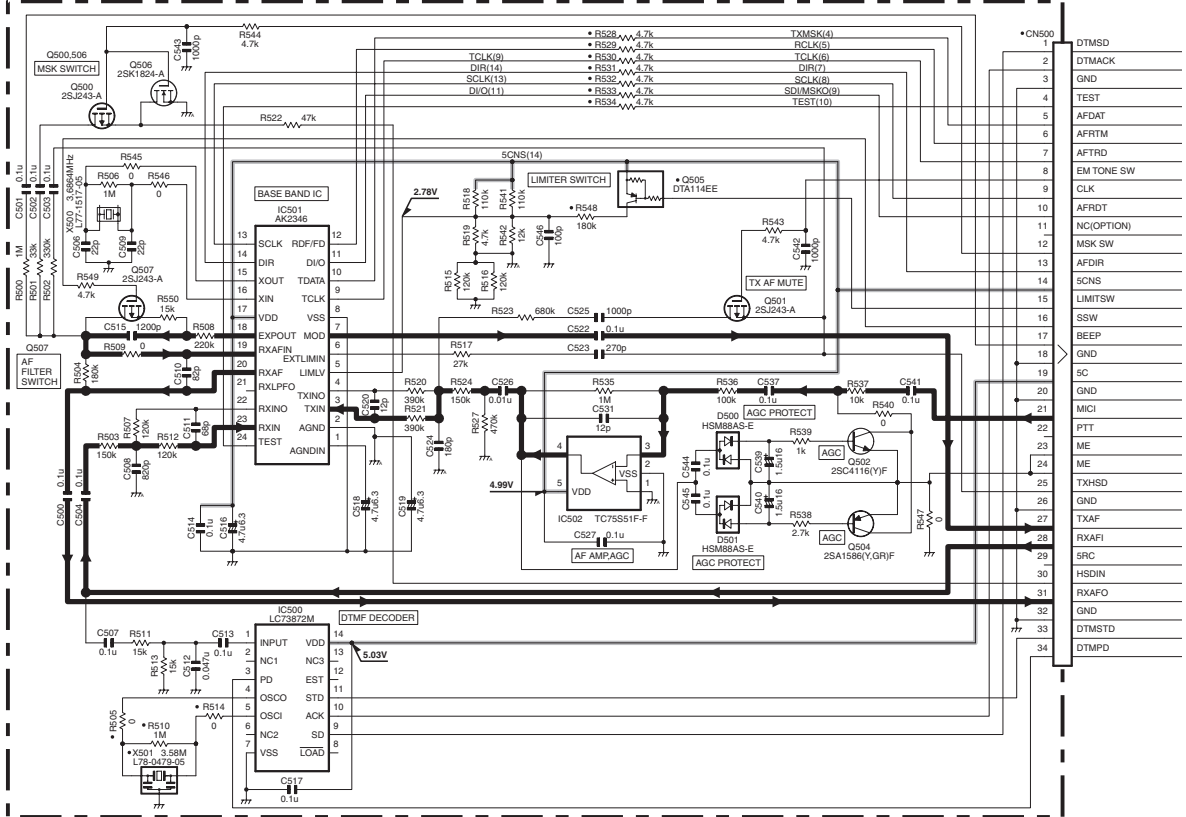

SCHEMATIC DIAGRAM TK-3140

TX-RX UNIT (X57-641X-XX)

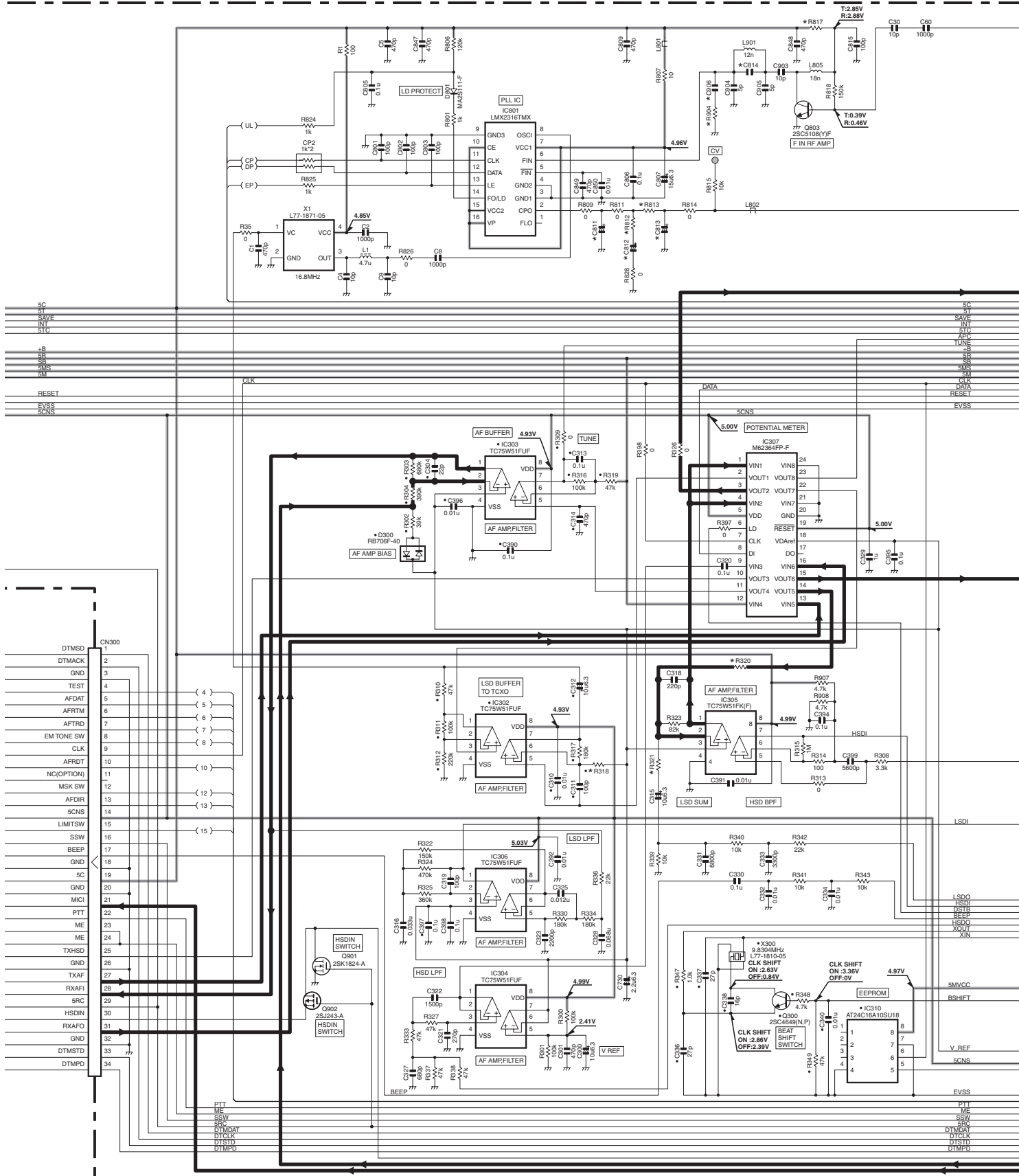

X57-641X-XX	R316	R320	R321	R812	R813	R817	R904	C811	C812	C813	C814	C906	
-71	E	68k	56k	390k	4.7k	8.2k	1k	56	0.1u5	1.0u16	0.047u35	3p(B)	1000p
-72	E3	39k	68k	560k	2.2k	1.5k	100	NO	0.33u35	3.3u10	0.33u35	3.5p(B)	NO

TK-3140 SCHEMATIC DIAGRAM

TX-RX UNIT (X57-641X-XX)

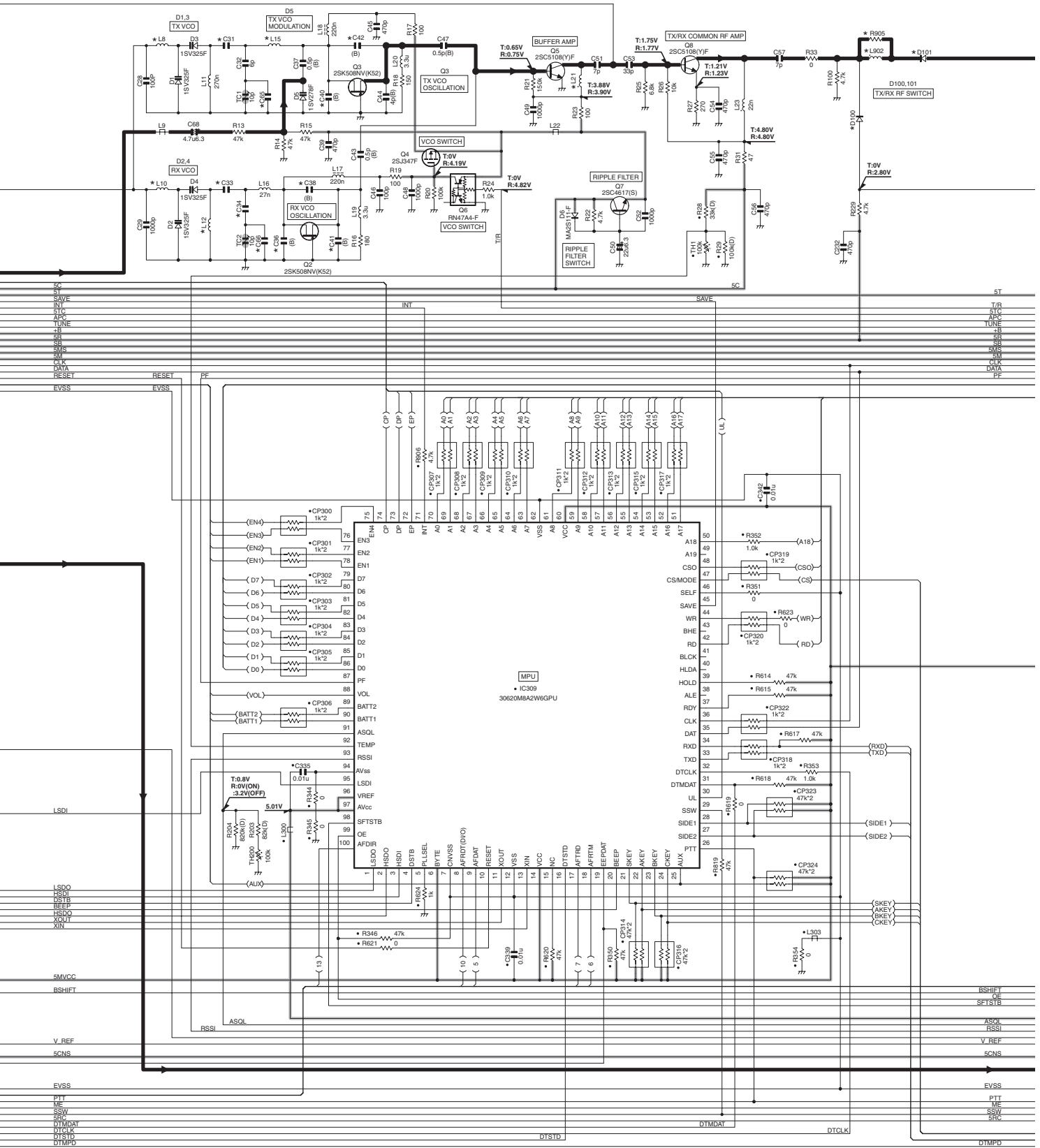

X57-641X-XX	L8	L10	L12	L15	L21	L902	R905	C31	C33	C34	C36	C38	C40	C41	C42	C65	C66	D100	D101	
-71	E	100n	100n	100n	22n	18n	9p	15p	5p	3.5p(B)	4p(B)	3p(B)	4p(B)	3.5p(B)	3p	2p	HSC277	HSC277	HSC277	
-72	E3	270n	3.3u	3.3u	27n	27n	NO	0	20p	56p	10p	3p(B)	5p(B)	2p(B)	9p(B)	2.5p(B)	1p	1p	HVC131	HVC131

SCHEMATIC DIAGRAM TK-3140

TX-RX UNIT (X57-641X-XX)

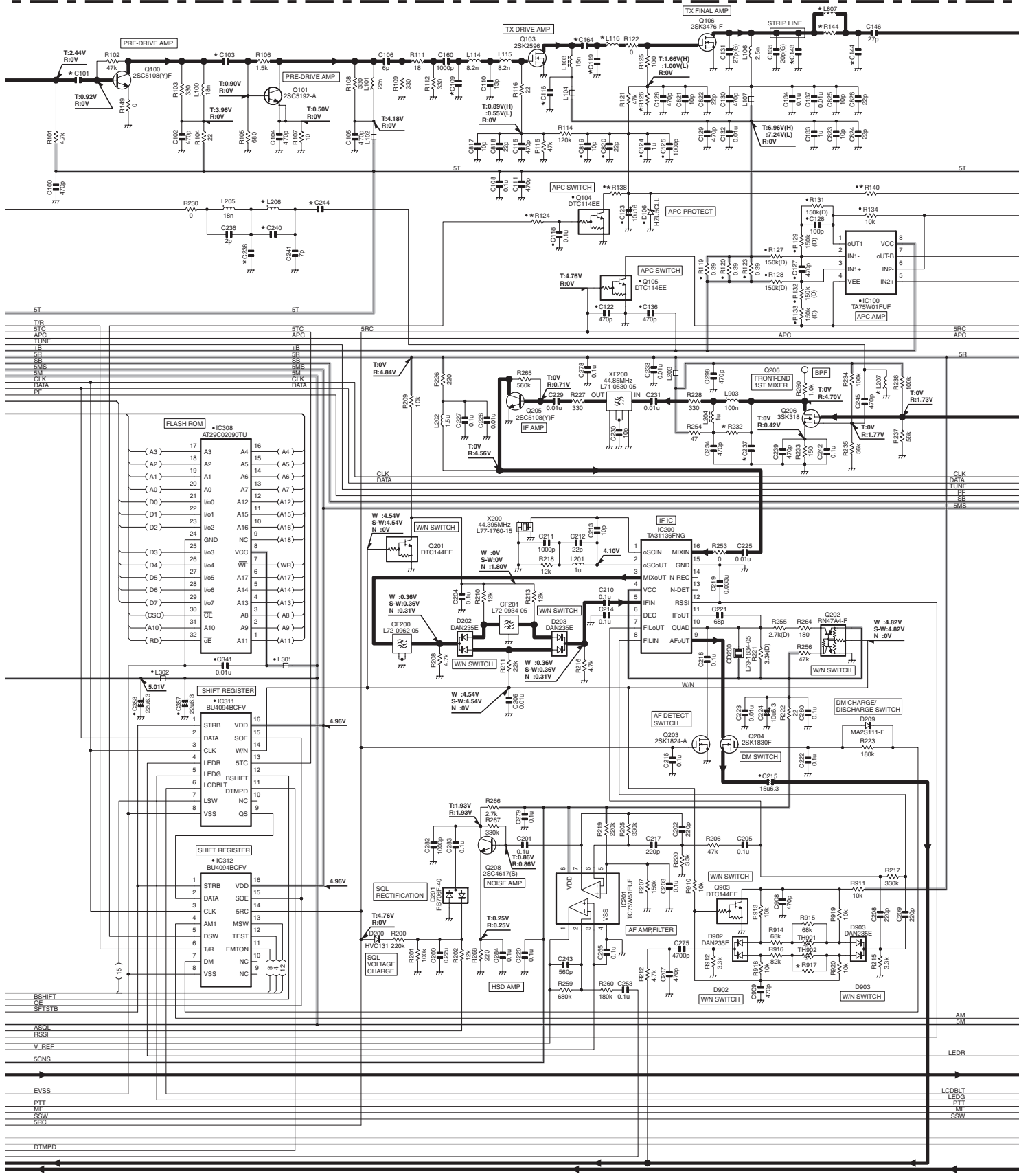

X57-641X-XX	L116	L206	L207	L807	R124	R126	R138	R140	R144	R232	R917	C101	C103	C109	C116	C119	C143	C144	C164	C237	C238	C240	C244	
-71	E	1.2n	22n	27n	NO	0	47k	1k	2.7k	0	4.7k	68k	470p	7p	5p	10p	27p	10p	7p	33p	18p	10p	0.75p	5p
-72	E3	1.5n	18n	33n	3.3n	39k	39k	3.3k	2.2k	NO	1k	120k	7p	9p	8p	33p	39p	15p	8p	100p	15p	11p	1p	3p(B)

TK-3140 SCHEMATIC DIAGRAM

TX-RX UNIT (X57-641X-XX)

Note : The components marked with a dot (●) are parts of layer1.

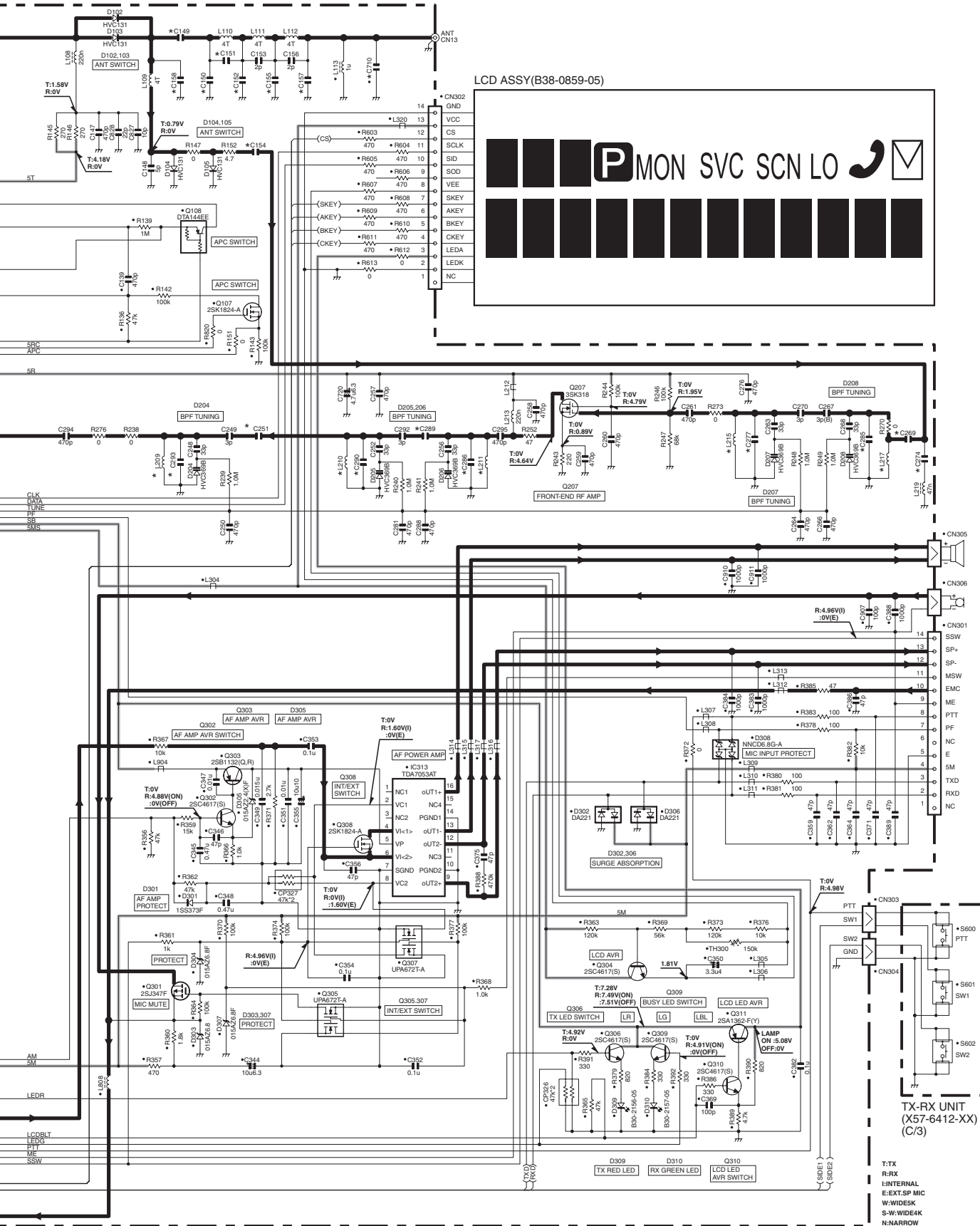

	L209	L210	L211	L215	L217	C149	C150	C151	C152	C154	C155	C157	C158	C251	C269	C274	C277	C285	C286	C289	C290	C293	C710	
-71	E	8.2n	8.2n	8.2n	8.2n	100p	3p	1.5p	4p	15p	5p	1p	3p	2p(B)	3p	3p	3.5p	0.5p	5p(B)	2p(B)	3.5p(B)	2p(B)	2.5p	
-72	E3	10n	10n	10n	10n	10n	470p	7p	1p	6p	13p	6p	4p	0.5p	3p(B)	4p	3.5p(B)	3p	NO	4.5p(B)	3p(B)	1.5p(B)	1.5p(B)	NO

1
2
3
4
5
6
7

T:TX
R:RX
I:INTERNAL
E:EXT-SP MIC
W:WIDE SK
S-W:WIDE4K
N:NARROW

TK-3140

Kenwood Corporation

2967-3, Ishikawa-machi, Hachioji-shi, Tokyo, 192-8525 Japan

Kenwood U.S.A. Corporation

P.O. BOX 22745, 2201 East Dominguez Street, Long Beach,
CA 90801-5745, U.S.A.

Kenwood Electronics Canada Inc.

6070 Kestrel Road, Mississauga, Ontario, Canada L5T 1S8

Kenwood Electronics Deutschland GmbH

Rembrücker Str. 15, 63150 Heusenstamm, Germany

Kenwood Electronics Belgium N.V.

Leuvensesteenweg 248 J, 1800 Vilvoorde, Belgium

Kenwood Electronics France S.A.

L'Etoile Paris Nord 2, 50 Allée des Impressionnistes,
Bp 58416 Villepinte, 95944 Roissy Ch De Gaulle Cedex

Kenwood Electronics UK Limited

KENWOOD House, Dwight Road, Watford, Herts.,
WD18 9EB United Kingdom

Kenwood Electronics Europe B.V.

Amsterdamseweg 37, 1422 AC Uithoorn, The Netherlands

Kenwood Electronics Italia S.p.A.

Via G. Sirtori, 7/9 20129 Milano, Italy

Kenwood Ibérica, S.A.

Bolivia, 239-08020 Barcelona, Spain

Kenwood Electronics Australia Pty. Ltd.

(A.C.N. 001 499 074)

16 Giffnock Avenue, Centrecourt Estate, North Ryde, N.S.W. 2113 Australia

Kenwood Electronics (Hong Kong) Ltd.

Unit 3712-3724, Level 37, Tower one Metroplaza, 223 Hing Fong Road,
Kwai Fong, N.T., Hong Kong

Kenwood Electronics Singapore Pte Ltd

1 Ang Mo Kio Street 63, Singapore 569110

